

TRANSISTOR MUSEUM™ HISTORIC GERMANIUM COMPUTER TRANSISTORS

IBM

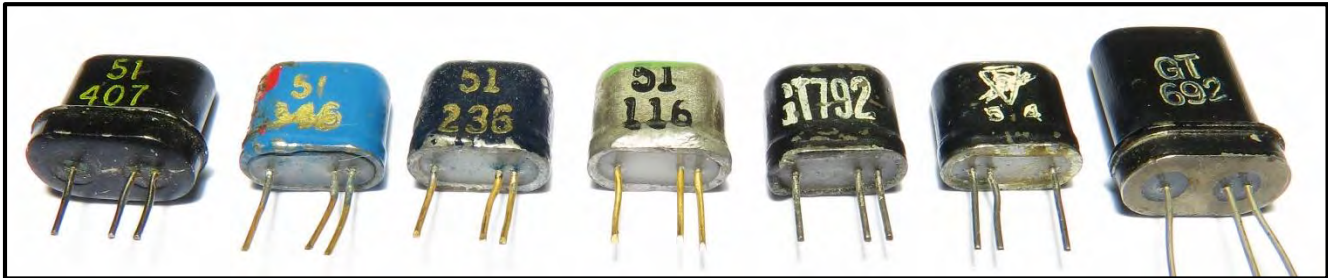

IBM TRANSISTOR TYPES

Type	Part #	Usage	Machine
PNP Transistors			
01	345741	Voltage Mode Trigger	608
02	345742	Voltage Mode E. F.	608
03	345743	Voltage Mode Neon Driver	608
04	345744	Voltage Mode Line Driver	608
06	345745	Sense Amplifier	608
12	340709	Relay Driver, 48v	738
13	344892	100KC Current Switching Ckts	608
14	345763	Neon Driver, 45v	729
15	526797	Drift-Current Switching	
16	526880	Drift-Current Switching	
17	526882	Drift-Development Use Only	
20	526795	25v Line Driver	729
21	526796	Read-Write Driver	729
22	526898	Power Transistor	729
23	526899	Relay Driver, 48v	729
24	362090	Relay Driver, 20v	608
NPN Transistors			
51	345747	5v Trigger	608
52	345748	Voltage Mode E. F.	608
54	345749	Voltage Mode Line Driver	608
57	345750	Core Driver	608
63	344891	100KC Current Switching	
65	526798	Drift-Current Switching	
66	526881	Drift-Current Switching	
67	526883	Drift-Development Use Only	

Type 01/51 PNP - NPN. These are saturating types of transistors specified for the IBM 608 voltage-mode circuits and used in trigger, inverter, and level-setter circuits. These transistors have a minority carrier storage (V_{st}) test, which none of the others must meet. This parameter, plus the minimum α' of 50, makes these transistors difficult and expensive to produce.

Type 02/52 PNP - NPN. These are similar to the 01/51 devices except for somewhat relaxed specifications; V_{st} is not specified here. These transistors are used in emitter-follower circuits where they are never driven into saturation. Types 01/51 may be used in circuits calling for 02/52 units; however, 02/52 transistors may not be used in circuits calling for 01/51 units.

Type 03 PNP 60-Volt Neon Driver. The predominant characteristic of this transistor is its high punch-through voltage (60 volts). It is used to drive neon indicators.

Type 04/54 PNP - NPN. Specifications for these transistors are the same as for the 01/51, except that the collector current is measured at the higher values of 10 and 50 ma. These types are used in line driver and power inverter voltage mode circuits.

Type 06 PNP. Specifications for this transistor are the same as for the type 01, but an additional performance test is made to simulate its application as a sense amplifier to detect and amplify small magnetic core impulses.

Types 12/23/24 PNP. The 12 and 23 are power devices designed to drive 48-volt relays. The problems of stability and cost of the types 12 and 23 units, along with a low-voltage approach to relays, brought about the type 24 transistor. It is used for driving the IBM 608 20-volt relays.

Early IBM Transistors: Shown at top are a series of early IBM transistors that were qualified for use in the Model 608 calculator, introduced in 1955. The chart above lists the range of IBM transistors types available at this time. IBM used transistors manufactured by other companies for the 608 as well as transistors manufactured by IBM. For example, the leftmost type 51 above is date code 1957 week 40 and is identifiable as an IBM device based on the unique oval case shape and "two-hole" bottom header construction. The three next type 51 transistors, with date codes in 1956, are likely Sylvania devices and are shown next to two 1955 Sylvania GT792 transistors with performance similar to the type 51. The device on the far right is another mid-1950s Sylvania transistor, type GT692, manufactured to meet IBM specifications including the "double-height" case style.

TRANSISTOR MUSEUM™ HISTORIC GERMANIUM COMPUTER TRANSISTORS

IBM

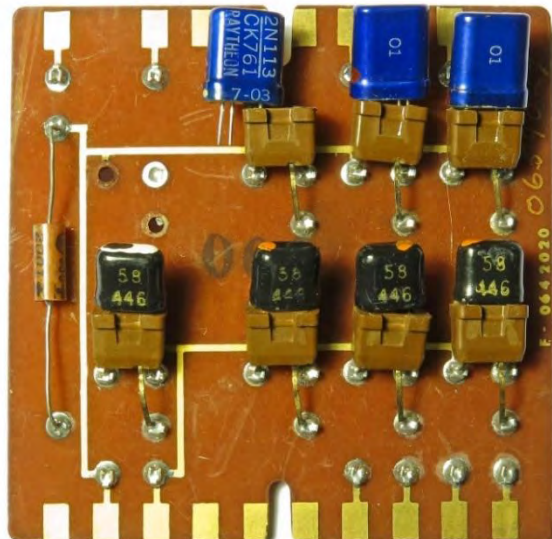

Early IBM Transistor Computer Circuit Boards:

The above image is a section of a 1955 Fortune magazine ad introducing the IBM 608, which was the first completely transistorized calculator available for commercial installation. It contained more than 3,000 transistors. Note the collection of six transistors plugged into sockets across the top of one of the circuit boards used in the 608. All of these transistors appear to be manufactured by other companies and not by IBM. For example, the yellow cased transistor is likely a Texas Instruments type 200 and the silver units are either Sylvania or Radio Receptor types. The circuit board at top right holds four type 58 transistors, with date code 1956 week 44, and three Raytheon 2N113/CK761 devices (also labeled IBM type 01) dated 1957 week 3. The historic object at right is on display at the Computer History Museum and is an example of an early IBM experimental transistor digital logic board. The two socketed transistors are of IBM manufacture, type 58, with date code 1957 week 2. The circuit boards shown on this page provide insight into mid-1950s IBM transistor technology, including the documented use of a variety of non IBM transistors in computer applications.



Photo Copyright (C) Mark Richards
[Object on Display at the Computer History Museum](#)
Donated by Joe Logue

TRANSISTOR MUSEUM™ HISTORIC GERMANIUM COMPUTER TRANSISTORS

IBM

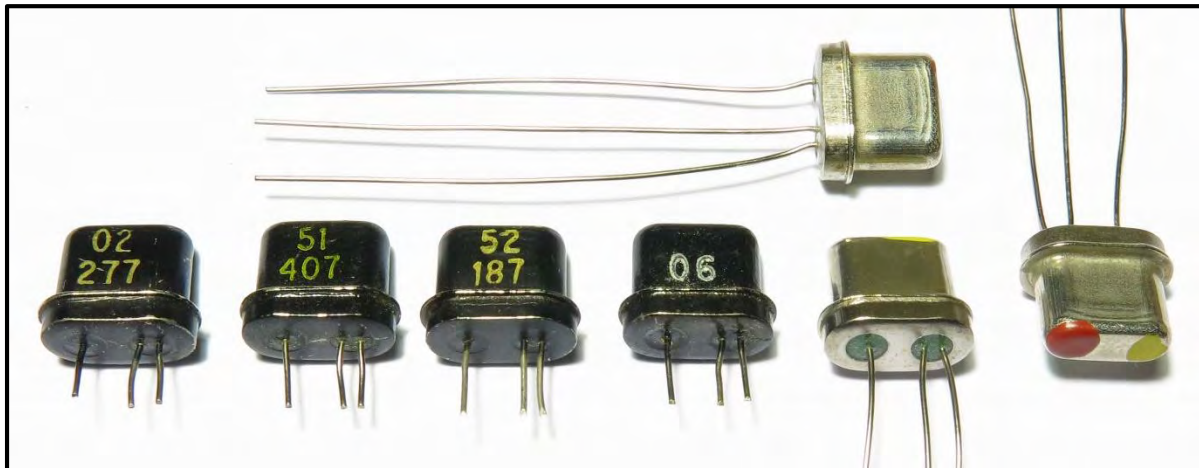

1957 Production Units - Alloy Junction: The black case transistors shown above at left are examples of devices manufactured on the first IBM pilot line established in 1956 to provide transistors for the 608 calculator. The above black units have date codes from 1957 and are typical in case construction and header design of the first IBM production types. The PNP units, such as the types 02 and 06, were constructed with an N-type germanium chip onto which were alloyed two P-type (indium) dots to form the PNP structure. The NPN units, such as the types 51 and 52, were constructed with a P-type germanium chip onto which were alloyed two N-type (lead-antimony) dots to form the NPN structure. Although the 608 calculator was announced in 1955, the first shipments did not occur until 1957, so it is likely that IBM manufactured transistors, such as those shown here, were installed in the customer delivered products, while the transistors used in the 1955 and 1956 development models of the 608 were supplied by other companies such as Radio Receptor, Raytheon, Sylvania, and TI. The first production IBM alloy junction transistor types supplied with your research kit will be of the type shown above left, with one of the model numbers shown.

1959 Experimental Test Units - PNP Alloy Junction: The silver transistors shown above right are all IBM PNP alloy junction types and were included in a large group of transistors which were subjected to a variety of electrical tests in a 1959 pre-production environment, with parameters of the group recorded on dated test sheets. There are no markings on these transistors, except the frequent use of paint dots on the case tops which likely indicated a lot number or test range. These are truly historic devices and your research kit will contain one of the units as shown above right.

<p>TRANSISTOR MUSEUM Historic Semiconductor Data</p> <p>Device ID: <u>IBM first production transistors</u></p> <p>Type: <u>Germanium PNP/NPN alloy junction</u></p> <p>Case Color/Style: <u>Black metal oval</u></p> <p>Vintage/Date Code: <u>1957</u></p> <p>Use: <u>1950s IBM solid state computers</u></p> <p>Notes: <u>Rare IBM transistors from first pilot production line. Used in 1955 608 calculator.</u></p>
--

<p>TRANSISTOR MUSEUM Historic Semiconductor Data</p> <p>Device ID: <u>IBM experimental test transistors</u></p> <p>Type: <u>Germanium PNP alloy junction</u></p> <p>Case Color/Style: <u>Silver metal oval</u></p> <p>Vintage/Date Code: <u>1959</u></p> <p>Use: <u>1950s IBM solid state computers</u></p> <p>Notes: <u>Historic IBM device from selected group of 1959 test transistors. Very rare.</u></p>

TRANSISTOR MUSEUM™ HISTORIC GERMANIUM COMPUTER TRANSISTORS

IBM

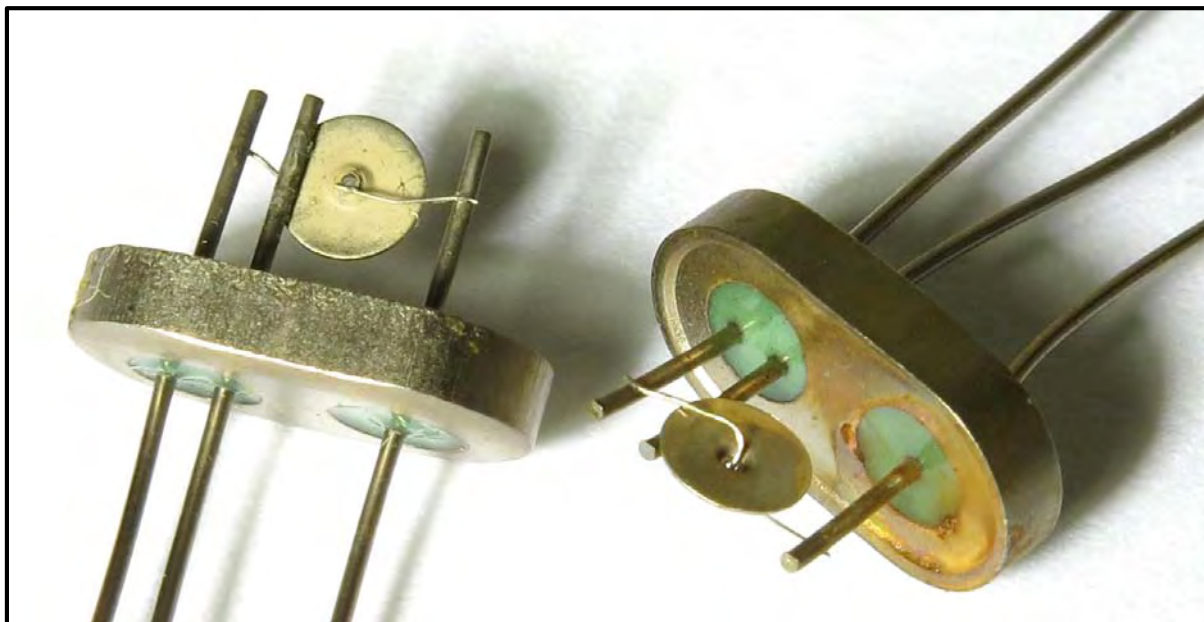

Early IBM Production Transistor Construction:

The top cases have been removed from two IBM alloy junction transistors to provide a more detailed view of the construction of these mid-1950 devices. Consistent with the germanium alloy junction process initially developed by GE and RCA, and used by most transistor manufacturers in this timeframe, the assembly of these transistors was largely a manual process performed by well-trained and highly dexterous production personnel, with tools such as a microscope, soldering or bonding equipment and assorted manual manipulators that would be at home in a watch repair shop. The circular disk shown above in each transistor is a washer which makes an ohmic contact to the small germanium die mounted at the indented area in the center of the washer, which has been soldered to the center or base lead exiting the bottom of the case. The emitter and collector leads has been soldered to the alloyed junction areas on each side of the germanium die and also to the appropriate end leads accessible through the green glass case header.

I. B. M. TRANSISTORS

DESCRIPTION:

PNP and NPN alloy junction switching transistors have been developed for use in complementary type circuits including the emitter follower, inverter and trigger circuits.

The basic transistor is a 50 mw unit with a relative constant common emitter current gain of 50, a frequency cut off above 5 mc and an average turn-on time of 0.1 microseconds. The small turn-off delay time permits operation in the voltage saturation region. The IBM transistor is a hermetic sealed unit which is capable of withstanding nominal temperature-humidity cycling, thermal shock test and vibration test.

MAXIMUM RATINGS

Collector - Base Voltage	20 V	@	55°C
Emitter - Base Voltage	20V	@	55°C
Punch Thru	15V		
Collector Dissipation	35 mw	@	55°C
Storage Temperature	-18°	to	75°C
Max Junction Temperature			75°
Collector Capacity	30 uuf	@	Vcb = -5V Ie = 5ma
Cut Off Frequency	5 mc	@	Vcb = -5V Ie = 3ma

Shown above is a section of an IBM data sheet supplied to the Army Signal Corps in 1956. Note the relatively low cutoff frequency of 5 Mc for these early IBM alloy junction transistors.

TRANSISTOR MUSEUM™ HISTORIC GERMANIUM COMPUTER TRANSISTORS

IBM



Late 1950s Drift Transistors: Although transistor technology offered many advantages over vacuum tube technology in the 1950s, high frequency performance required for faster computer switching circuits was not achieved by commercial transistors until the mid to late 1950s with the development of new types, such as the drift transistor. The RCA 2N247, introduced in 1956, was the first commercially available drift transistor, and provided stable operation up to 30 Mc. Although the first IBM transistors were alloy junction types with a high frequency limit of up to 5 Mc, planning to develop higher speed transistors began at IBM as early as 1955. By 1957, IBM was producing PNP and NPN complementary drift transistors consisting of an alloyed emitter and diffused base. Also in this timeframe, IBM was developing a completely mechanized system for transistor assembly to expand the low volume production capability that had been established in 1956. High volume production of transistors was a requirement in order to meet the expected needs of newly designed computers such as project Stretch.

IBM Type 065 NPN Drift Transistor: Using the standard TO-5 case style, the two devices shown above left are early NPN IBM drift transistors which were manufactured during the timeframe that IBM was finalizing the automated transistor assembly system. These devices are dated 1958 and are quite unique in that each transistor was serialized - this was accomplished with a stamped metal strap around the outside of the case. An example of the serial number digits in this particular lot of transistors is "38280".

TI Type 065 NPN Drift Transistor: As noted earlier, IBM was working with other transistor manufacturers in the mid-1950s in order to meet the large quantity requirements for new computer development and production. Texas Instruments was a major supplier of transistors to IBM and in the early 1960s partnered with IBM for automated transistor production. The units shown above right are manufactured by TI, with date code 1959 week 4. These devices are also serialized, but in this case with handwritten tags. An example of the serial number digits in this particular lot of transistors is "14143".

TRANSISTOR MUSEUM Historic Semiconductor Data
Device ID: <u>IBM Type 065 transistor</u>
Type: <u>Germanium NPN drift</u>
Case Color/Style: <u>Silver metal TO-5</u>
Vintage/Date Code: <u>1958</u>
Use: <u>1950s/1960s IBM solid state computers</u>
Notes: <u>Unique diffused base-alloyed emitter high speed transistor-used in project Stretch.</u>

TRANSISTOR MUSEUM Historic Semiconductor Data
Device ID: <u>TI-IBM Type 065 transistor</u>
Type: <u>Germanium NPN drift</u>
Case Color/Style: <u>Silver metal TO-5</u>
Vintage/Date Code: <u>1959</u>
Use: <u>1950s/1960s IBM solid state computers</u>
Notes: <u>TI manufactured version of IBM 065 drift transistor-used in project Stretch.</u>

TRANSISTOR MUSEUM™ HISTORIC GERMANIUM COMPUTER TRANSISTORS

IBM

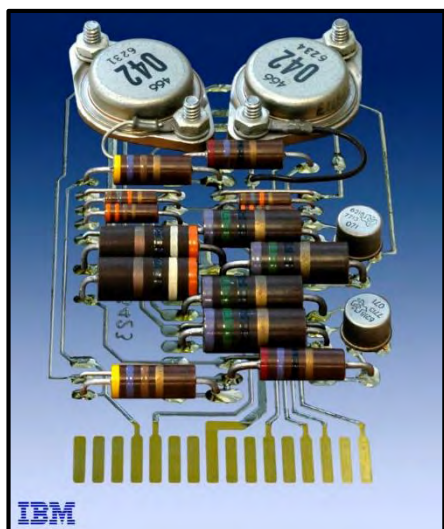
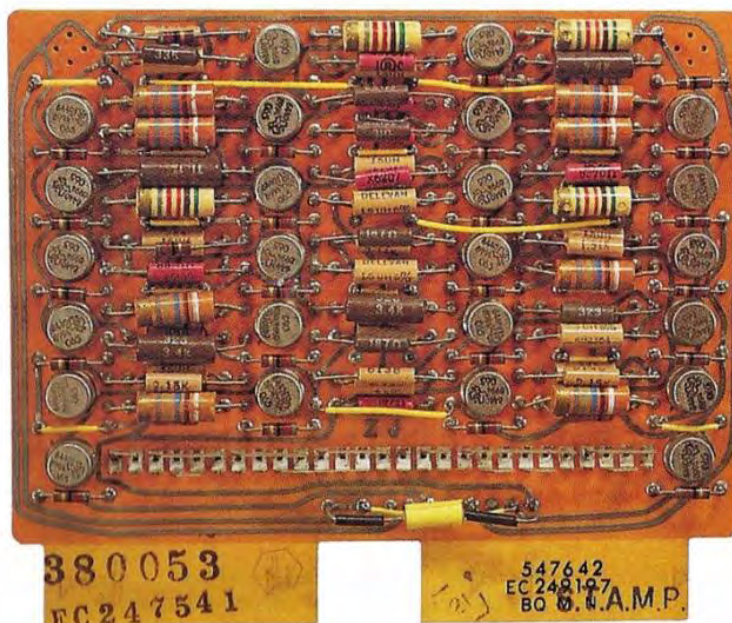

Photo Copyright (C) John Pratt
On Display at the University of Auckland
[Computer Science Webpage](http://www.computer-science.org.nz)



IBM SMS Computer Circuit Boards: Beginning in 1959, IBM standardized the format for the design and fabrication of solid state printed circuit boards used in most computers throughout the 1960s. These boards, known as standard Modular System (or SMS), were made in single width (2.5" wide) and double width (5.3" wide) and were 4.5" in depth. Printed circuit "runs" on the backside of the board were used to make the required component connections. At upper right is an SMS board from the mid-1960s with 24 TI transistors, most of type 065 NPN drift transistor. At lower right is another mid-1960s SMS board, which has both TI (type 025) and GE (black type 033) alloy junction transistors. The unique "clear through" view of a single width SMS board at upper left allows a view of the printed circuit "runs" on the back of the card. This card has two TI 071 core driver transistors (see closeup) and two Delco type 042 power transistors. The SMS technology was very successful and IBM manufactured large numbers of these boards.

TRANSISTOR MUSEUM™ HISTORIC GERMANIUM COMPUTER TRANSISTORS

IBM



SWITCHING TRANSISTOR

Lloyd P. Hunter, Poughkeepsie, Richard F. Rutz, Fishkill, and Gardiner L. Tucker, Glenham, N. Y., assignors to International Business Machines Corporation, New York, N. Y., a corporation of New York
Application November 22, 1955, Serial No. 548,310

2,810,870

Oct. 22, 1957

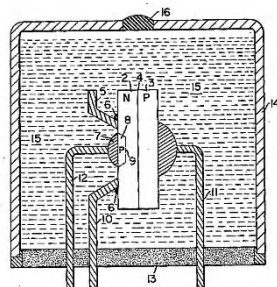

IBM Transistors into the 1960s:

As an indication of the rapid shift from vacuum tubes to transistor technology by IBM in the 1950s, the display above provides an interesting tally of the number of transistors used by IBM during this timeframe. As noted earlier, the first all transistor IBM commercial product, the 608 calculator, was announced in 1955. In order to reach the milestone of 10,000,000 transistors only five years later from a single industry supplier, the number of transistors used by IBM in this early timeframe is quite impressive. By the late 1950s, TI was the primary supplier of germanium transistors to IBM, although other suppliers were also used and IBM continued its own limited production of transistors into the 1960s. The early IBM germanium transistors were alloy junction devices, which were adequate for many low frequency applications, but the ever increasing demand for faster computers required higher switching speed transistors. IBM began development work on the high speed drift transistor technology in the mid-1950s, with its first patent filed in 1955 (see composite image at upper left). As described in this patent, the base-collector junction was created by diffusion of a thin base layer, into which a second diffusion implanted a graded level of impurities. The emitter junction was alloyed. Devices based on this technology were put into production by IBM in the mid to late 1950s. A second IBM drift transistor patent was filed in 1957 (lower left) which defined a drift structure that supported more controlled manufacturing processes. Devices based on this technology were put into production by IBM in the late 1950s.

SEMICONDUCTOR DEVICES AND METHOD OF MAKING SAME

Robert S. Schwartz and Bernard N. Slade, Poughkeepsie, N.Y., assignors to International Business Machines Corporation, New York, N.Y., a corporation of New York
Filed June 6, 1957, Ser. No. 664,069

3,001,895

Patented Sept. 26, 1961

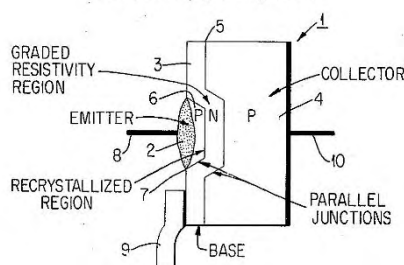

TRANSISTOR MUSEUM™ HISTORIC GERMANIUM COMPUTER TRANSISTORS

IBM

Transistor Identification and Substitution

General Usage	Manufacturing Process	Form	IBM Type No.	IBM P/N	Circuit Application *	Notes			
Logic	Alloy Junction	PNP	01	345741	VM (S)	1 2 3 6 7 8			
			02	345742	VM (NS)				
			13	344892	CS (NS)				
			25	318322	CS, CTRL, CTDL(S) (NS)				
			29	492451	CTDL(S)				
			33	318324	CS, CTRL, CTDL(S) (NS)				
		34	535009	CTDL(S)					
		NPN	51	345747	VM (S)				
			52	345748	VM (NS)				
	63		344891	CS (NS)					
	Diffused Junction	PNP	15	526797	CS (NS)				
			16	526880	CS (NS)				
			18	347592	CS (NS)				
		NPN	65	526798	CS (NS)				
			66	526881	CS (NS)				
			68	347593	CS (NS)				
			Special Purpose	Power Drivers	NPN PNP	04	345744	(S) Line Driver	4 5
						06	345745	(S) Sense Amplifier	
12						340709	(S) 48v Relay Driver		
14	345763	(S) 45v Neon Driver							
20	526795	(S) 25v Line Driver							
21	526796	(S) Read-Write Driver							
22	526898	(S) Prolay and Power Driver							
23	526899	(S) 48v Relay Driver							
26	535441	(S) 20v Relay Driver							
Diffused Junction (Medium) (Power) Drivers	NPN	71			492450	(S) Slow Speed Core Driver			
		88	369558	(NS) Core Memory Driver					
		89	369559	(NS) Core Memory Driver					
	NPN	91	369561	(S) Shift Register and Drum Driver					
		92	369562	(S) Shift Register and Drum Driver					
		93	369560	(NS) Core Memory Driver					

* Circuit Application
 VM - Voltage Mode
 CS - Current Switching
 CTRL- Complementary Transistor Resistor Logic
 CTDL- Complementary Transistor Diode Logic
 (S) - Saturating
 (NS)- Non-saturating

Editor Note: The power driver list has been corrected to indicate PNP types.

Notes:

1. Type 13 can be used for type 33 or 25
2. Type 25 cannot be used for type 33
3. Type 33 can be used for type 25
4. A Delco 2N174 can be used for type 22
5. A Philco 1229 can be used for type 23
6. Type 63 can be used for type 83 or 75
7. Type 75 cannot be used for type 83
8. Type 83 can be used for type 75

Late 1950s IBM Transistor Chart:

The above chart is from a 1959/1960 IBM SMS Customer Service Component Manual and is a comprehensive list of the IBM germanium transistor types available at this time. The types identified as "Diffused Junction", such as the O65, are drift transistors. The various notes supplied with this chart are helpful in further documenting early IBM transistor technology. Early 1960s SMS boards were manufactured with these transistor types, and contained both IBM and industry supplied transistors.

TRANSISTOR MUSEUM™ HISTORIC GERMANIUM COMPUTER TRANSISTORS

IBM



1960s Delco Germanium Power Transistors: The technology required to manufacture germanium power transistors was developed by only a few semiconductor companies in the 1950s/1960s, and these companies were the primary suppliers to the electronics industry of these specialized device types. The best known germanium power transistor manufacturers were CBS, Clevite, Delco, Motorola, RCA and Sylvania. There is little documentation to indicate that IBM actively developed and manufactured these device types. It is well documented that IBM bought transistors of this type from other companies, primarily from Delco. The use of germanium power transistors was common in early IBM solid state computers and related data processing equipment, beginning as early as the mid-1950s with the type 022 transistor used in the in the model 729 magnetic tape unit. The germanium power transistors shown above are all PNP types, manufactured for IBM by Delco. Although the Delco name doesn't appear on the transistors, the unique company identifier "466" is the EIA industry association corporate code for Delco. These devices are quite large and constructed with a substantial amount of copper heat sink - in addition, the specific case shape for these above devices is known as TO-6, a JEDEC industry standard that includes a bolt for mounting the transistor to an external heat sink for maximum heat dissipation and high power performance. Although these Delco transistors were identified with IBM type numbers, the standard "2N" numbering system was far more common. For example, the Delco types 2N173, 2N174, 2N277, 2N278, and 2N44X used this same TO-6 case style and were highly successful commercial devices used extensively in automobile radio audio output applications. Delco also qualified the high reliability JAN 2N174 to meet military use requirements. Your research kit will contain one of the early 1960s units shown above (type 022 or 049) and one of the late 1960s type 108.

TRANSISTOR MUSEUM
Historic Semiconductor Data

Device ID: IBM Types 022/049 transistor
 Type: Germanium PNP power alloy junction
 Case Color/Style: Silver metal TO-6
 Vintage/Date Code: 1950s/1960s
 Use: 50+ watt high power applications
 Notes: These Delco devices were used in power applications for many IBM computers.

TRANSISTOR MUSEUM
Historic Semiconductor Data

Device ID: IBM Type 108 transistor
 Type: Germanium PNP power alloy junction
 Case Color/Style: Silver metal TO-6
 Vintage/Date Code: Mid-late 1960s
 Use: 50+ watt high power applications
 Notes: These Delco devices were used in power applications for many IBM computers.

HISTORIC GERMANIUM COMPUTER TRANSISTORS

IBM

Trigger Happy Transistor

Everybody is talking about transistors. But, certain problems are not readily solvable by the use of conventional transistors. A typical problem is that of picking up a relay with a transistor controlled by microsecond pulses. So Richard Rutz, of our Semi-Conductor Devices Research Group, took a long look at transistor possibilities in this case. The result: The IBM X-4 Transistor. This new type permits high-speed switching of large currents by low-power electrical pulses. It operates with a turn-on time of two ten-millionths of a second and a turn-off time of one-millionth of a second; experimental models have been made to switch currents as high as 15 amperes.

You can find full scientific data on the X-4, its construction, electrical characteristics, and circuit applications in IBM Bulletin No. 101.

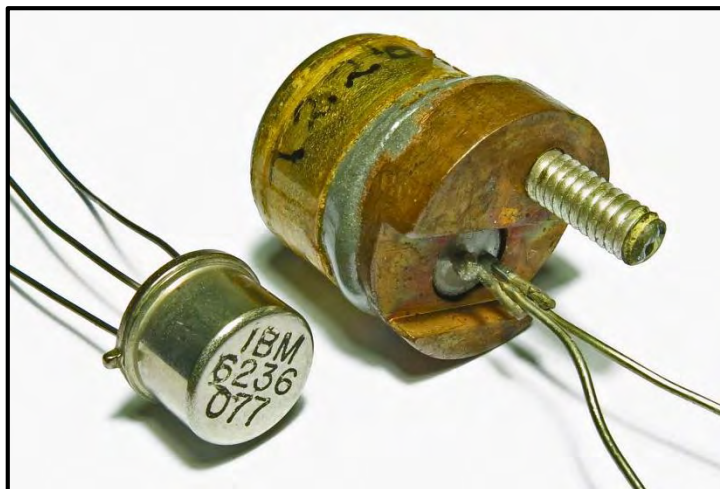
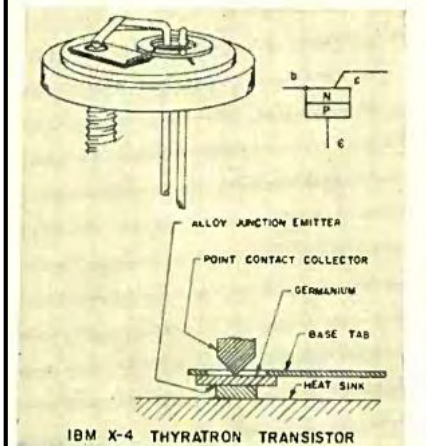

IBM Germanium Thyatron Transistors:

Beginning in the early 1950s, IBM researchers were involved in developing transistor types that would be suitable for the solid state computers soon to be commercialized. Although the initial research work was done with point contact transistors, later research activities focused primarily on alloy junction and drift transistor types. There was one notable exception in that IBM was also interested in developing a transistor type that would be an acceptable replacement for the vacuum tube thyatron technology that has been used in earlier vacuum tube computers. Thyatrons could be used in circuits to control relays and other electro-mechanical devices where high current capability and fast switching time was important. Shown at upper left is a section of a 1956 IBM ad describing this type of thyatron transistor research at the Semi-Conductor Devices Research Group. The IBM X-4 device discussed in the ad was a truly unique technology, combining alloy junction and point contact technologies in a single device. The X-4 likely was a lab or pre-production "proof of concept" device, and was not used in commercial applications. Shown above is an IBM thyatron X-4 transistor, serial # T226, which is placed next to a later production model thyatron type 077. IBM continued to develop this technology, and manufactured thyatron transistors with production level quality and quantity. At left is a section of an IBM patent for a germanium thyatron device structure consisting of four semiconductor layers (PNPN).

PNPN SEMICONDUCTOR TRANSLATING DEVICE AND METHOD OF CONSTRUCTION

Fred Barson, Wappingers Falls, and John Gow 3d, Marlboro, N.Y., assignors to International Business Machines Corporation, New York, N.Y., a corporation of New York Filed Apr. 28, 1960, Ser. No. 25,385 3,211,971 Oct. 12, 1965

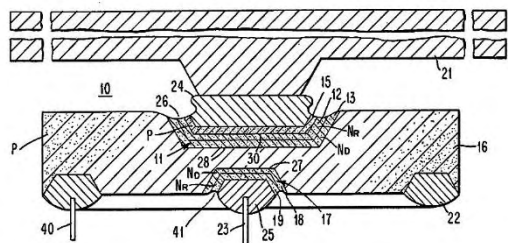

TRANSISTOR MUSEUM™ HISTORIC GERMANIUM COMPUTER TRANSISTORS

IBM

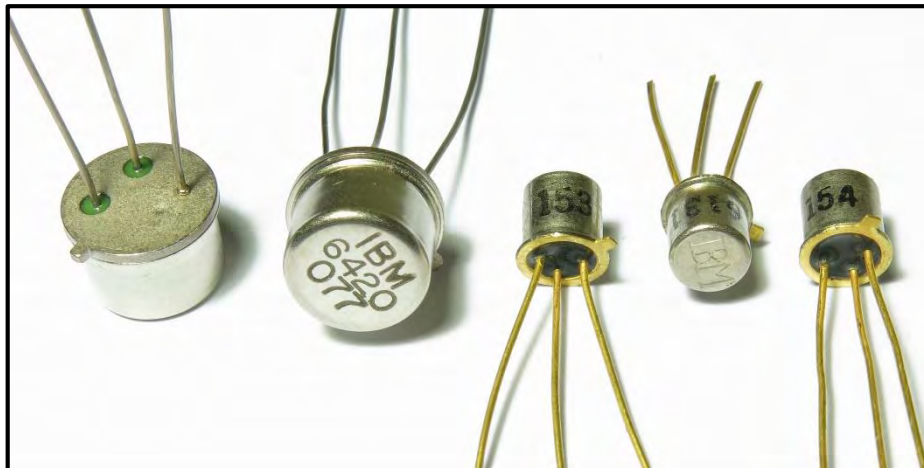

Type 077 PNP Germanium Thyatron Transistor: Although IBM purchased many germanium transistor types from outside vendors in order to meet the ever growing production requirements for their early solid state computers, IBM developed an in-house research and production expertise for the germanium thyatron transistor type and continued to manufacture this unique device into the 1960s. It is unlikely that IBM was able to procure this type of device from an outside vendor since all other four layer (PNPN) devices available in the industry were fabricated with silicon, and not germanium. Western Electric, GE, Westinghouse and, most famously Shockley Transistor Corporation, manufactured silicon PNP devices during the 1950s/1960s, but germanium types were not available. The IBM type 077 PNP germanium thyatron transistor is a truly historic device, and the units included in your research kit are still functional. Additional information about these unique transistors can be found in IBM patents 3211971, 3241012 and 3559054.

Types 153/154 Germanium Mesa Transistors: Throughout the 1950s and into the early 1960s, IBM continued to manufacture transistors as well as purchase large quantities from other companies. By the mid-1960s, IBM had ceased the manufacture of discrete transistors, and used outside vendors exclusively. The last transistor type to be manufactured in-house by IBM was the germanium mesa device, identified as types 151 - 165. The germanium mesa transistor was the "speed king" of other types in the late 1950s. Also of note is the fact that a photolithographic process was used during manufacture, which was a key factor in ensuring consistency and reliability. The mesa type was eclipsed a few years later with the advent of the Fairchild silicon planar transistor. Your research kit will contain one 153 or 154 IBM germanium mesa transistor from the early 1960s. These are rare devices and represent the final production transistor types manufactured by IBM.

TRANSISTOR MUSEUM Historic Semiconductor Data Device ID: <u>IBM Type 077 thyatron</u> Type: <u>Germanium PNP four layer device</u> Case Color/Style: <u>Silver metal TO-5</u> Vintage/Date Code: <u>Early-mid 1960s</u> Use: <u>High speed, large current switching</u> Notes: <u>Unique PNP switch developed by IBM to replace electron tube thyatrons.</u>

TRANSISTOR MUSEUM Historic Semiconductor Data Device ID: <u>IBM Types 153/154 transistor</u> Type: <u>Germanium NPN mesa</u> Case Color/Style: <u>Silver metal TO-18</u> Vintage/Date Code: <u>Early-mid 1960s</u> Use: <u>High speed logic switch</u> Notes: <u>Last transistor type manufactured by IBM. Used high performance mesa structure.</u>

TRANSISTOR MUSEUM™ HISTORIC GERMANIUM COMPUTER TRANSISTORS

IBM

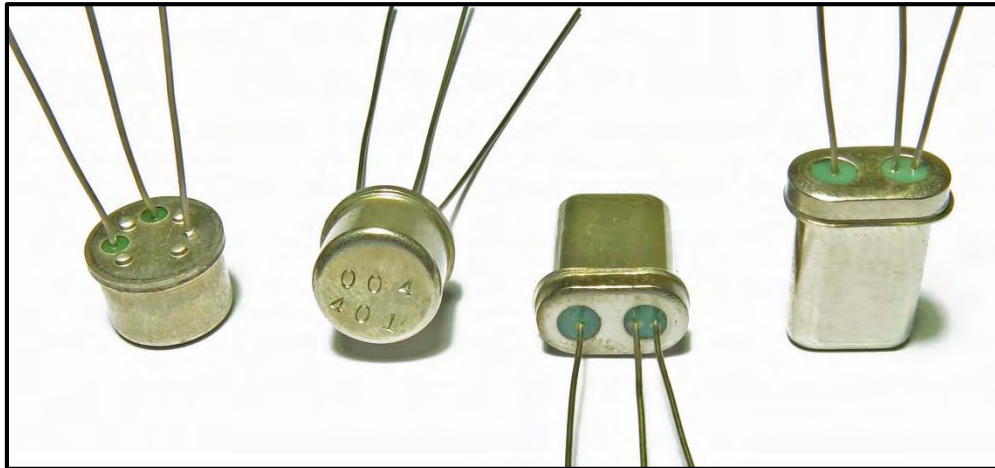

1959 Experimental Test Units - PNP Germanium Thyatron Transistors: As noted earlier, IBM continued research and development for this unique semiconductor type throughout the 1950s and into the 1960s, with the production type 077 available for commercial use in IBM solid state computers. The silver transistors shown above left are all IBM germanium thyatron transistors that were part of a large group of transistors which were subjected to a variety of electrical tests in a 1959 pre-production environment. The case style is quite unusual, similar to a standard TO-5, but with raised dimples on the base. All units have metal stamped identifiers on the top of these case - "004" appears to be a lot number, with a unique serial number stamped below. Shown above is serial number "401". These devices have been confirmed to be germanium devices by measuring the voltage drop across a PN junction. These are extremely rare semiconductors, and reflect the state of 1950s IBM research into this unique semiconductor device type.

1959 Experimental Test Units - PNP Drift Transistors: The first IBM patent (2,810,870) for a high speed drift type switching transistor was filed in Nov 1955, and was the basis for the early production types 065 and 066 from that timeframe. These were NPN devices and used the proprietary IBM case style based with the unique oval case shape and "two-hole" bottom header construction. By 1958, the type 065 drift transistor used the more standard TO-5 case and the basis for the drift structure was likely based on the later IBM patent 3,001,895 which was filed in June 1957. The units shown above right are from the lot of 1959 experimental test units - these are unusual devices because the uncommon "double-height" IBM case style is used and because these are PNP drift types. Although unmarked, these are probably similar in performance to the early production PNP drift types 015, 016 and 017.

TRANSISTOR MUSEUM
Historic Semiconductor Data

Device ID: IBM experimental test thyatron
 Type: Germanium PNP four layer device
 Case Color/Style: Silver metal TO-5
 Vintage/Date Code: 1959
 Use: High speed, large current switching
 Notes: Historic IBM device from selected group of 1959 thyatrons. Very rare.

TRANSISTOR MUSEUM
Historic Semiconductor Data

Device ID: IBM experimental test transistor
 Type: Germanium PNP drift
 Case Color/Style: Silver metal oval
 Vintage/Date Code: 1959
 Use: 1950s IBM solid state computers
 Notes: Unique "double-height" IBM case. Rare 1950s experimental PNP drift device.

TRANSISTOR MUSEUM™ HISTORIC GERMANIUM COMPUTER TRANSISTORS

IBM

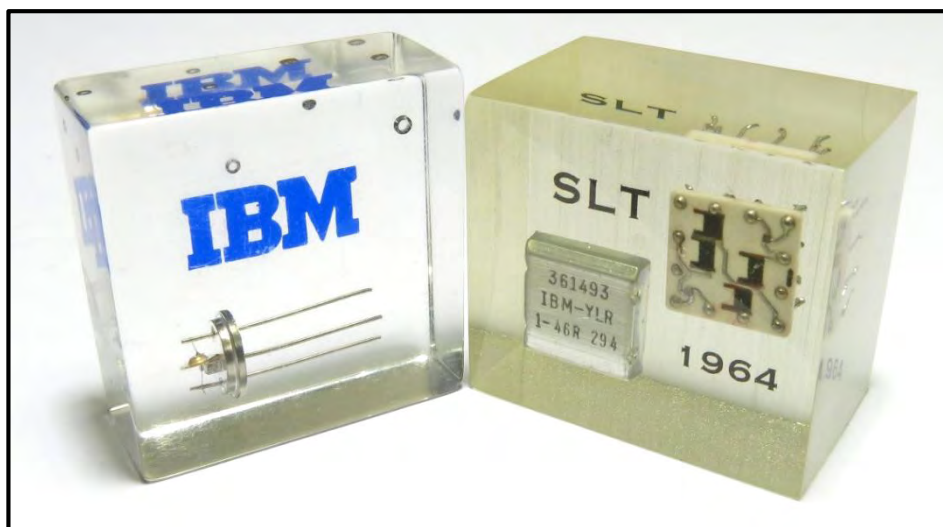

IBM - Into the Silicon Era: IBM continued production of germanium transistors into the mid-1960s, but also in this timeframe the company was planning for the next generation of circuit technology that would meet the needs of even faster and more complex solid state computers. The semiconductor technology approach chosen by IBM was known as SLT, or Solid Logic Technology, which was introduced in 1964 by IBM for use in the newly developed System/360 computer. SLT was a hybrid circuit technology that combined planar silicon semiconductors with passive components on a ceramic substrate to form a logic module building block, such as And-Or-Invert circuits. Shown above is a comparison of a mid-1950s IBM germanium transistor with a mid-1960s IBM silicon SLT logic gate. In a few short years, IBM semiconductor technology had progressed from manually assembled discrete germanium alloy junction transistors to SLT hybrid logic modules, which represented the industry's first high-volume, automatic, microminiature production of semiconductor circuits. Improved versions of IBM silicon technology soon followed, with SLD (Solid Logic Dense) and MST (Monolithic Systems Technology) - examples shown below. SLD technology enhanced the hybrid SLT approach and enabled from two to five logic circuits per module and MST implemented the first monolithic integrated circuits in IBM computer modules.



TRANSISTOR MUSEUM™

HISTORIC GERMANIUM COMPUTER TRANSISTORS

IBM

Additional References for IBM Transistor History

- 1) Bashe, Charles J., Johnson, Lyle R., Palmer, John H., Pugh, Emerson W. 1986. *IBM's Early Computers*. Cambridge, Massachusetts: The MIT Press.
- 2) Pugh, Emerson W., Johnson, Lyle R., Palmer, John H. 1991. *IBM's 360 and Early 370 Systems*. Cambridge, Massachusetts: The MIT Press.
- 3) Harding, William E. 1981. "Semiconductor Manufacturing in IBM, 1957 to the Present: A Perspective." *IBM Journal or Research and Development*, Volume 25, No. 5 (September), pp 647-658.
- 4) Garner, Robert., Dill, Frederick (Rick) 2010. "The Legendary IBM 1401 Data Processing System." *IEEE Solid-State Circuits Magazine*, Winter, pp 28-39.
- 5) Logue, Joseph C., 1998. "From Vacuum Tubes to very Large Scale Integration: A Personal Memoir." *IEEE Annals of the History of Computing*, Volume 20, No. 3, pp 55-68.
- 6) [The IBM 1401 Demo Lab and Restoration Project - Computer History Museum](#)
- 7) [Early Transistor History at IBM, Hannon Yourke Oral History - Transistor History Museum](#)
- 8) [IBM Archives - 608 Calculator](#)

This section of the Historic Germanium Computer Transistors Research and Collecting kit has included a number of observations, statements and conclusions regarding the early history of IBM transistor development. This Transistor Museum material has been based on a review of several highly informative publications and websites devoted to this topic. Because of the historical importance of IBM to the early development of solid state computers, the amount of research information available is substantial. For those interested in further research into early IBM semiconductors, the references shown above should provide a comprehensive "starting point". This list also is the basis for the Transistor Museum observations, statements and conclusions regarding the early history of IBM transistor development, and due credit should be given to the authors of these excellent resources. Some additional comments about these references:

- **References 1 and 2:** These two massive texts (700 and 800 pages respectively) are the most complete accounts of the history of IBM computers available. These texts are readable and comprehensive. Each includes detailed information on IBM transistor development and much of the factual information regarding IBM transistor history discussed in this Transistor Museum research material is based on the information in these two books.
- **References 3, 4 and 5:** These three research publications are excellent sources of detailed IBM transistor development history, with facts, insights and commentary from the authors, all current or past IBM employees with personal knowledge of this topic. These articles have provided substantial information regarding early IBM transistor development that has been used as supporting material for this research kit publication.
- **References 6, 7 and 8:** There are substantial online resources available covering IBM history. Of particular note is the Computer History Museum website, which has developed extensive coverage on this topic. Reference #6, for example, provides extensive information on the recent CHM project to restore a 1960s IBM 1401 solid state computer; many useful facts, pictures and links are also provided at this site.