

Reference Manual

1401 Data Processing System

Original Equipment Manufacturers' Information

The information in this manual will assist designers of accessory equipment for IBM 1401 Processing Units. Additional details about operation and use of the IBM 1401 Processing Unit in integrated data processing systems may be obtained from the local IBM sales office.

IBM

Reference Manual

1401 Data Processing System

Original Equipment Manufacturers' Information

obsolete, b.t. newer manual did not discuss switches

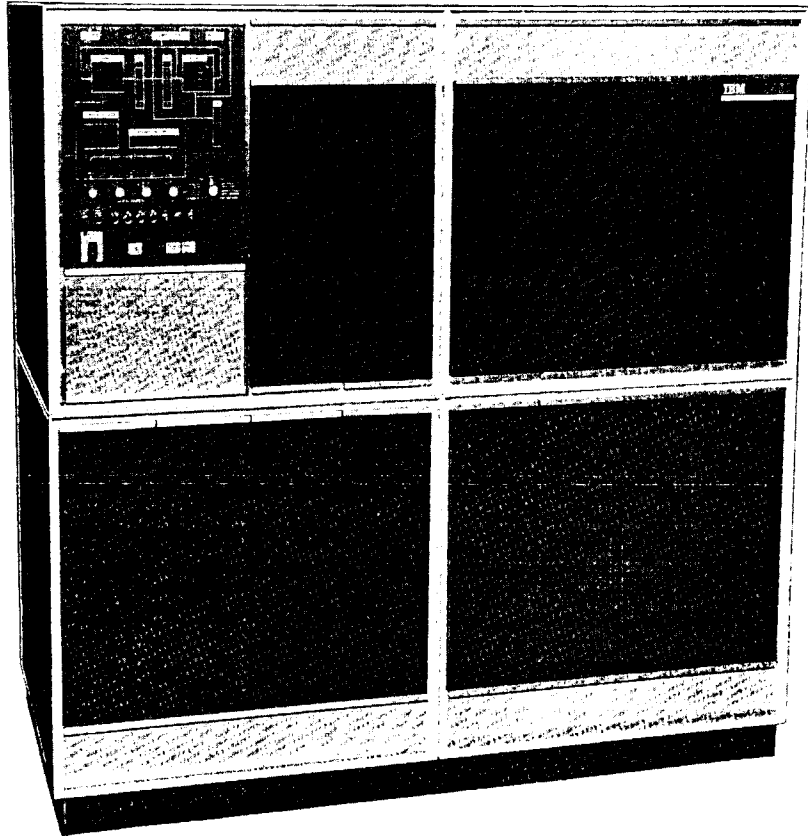

Figure 1. IBM 1401 Processing Unit

Contents

Introduction	5
Functional Characteristics	5
Core Storage	5
Instruction Format	5
A- and B-Registers	6
Address Registers	6
Word Mark	7
Checking	7
Input/Output Attachment	7
Physical Characteristics	7
Console	7
Auxiliary Console	10
Customer Engineering Diagnostic Panel	11
Power Requirements	13
Signal Levels	13
Input/Output Signal Lines	14
IBM 1401 Output Lines to I/O Unit	14
I/O Unit—Input Lines to IBM 1401	17
Connector Receptacle Pin Assignments	18

This manual is intended to provide sufficient data to satisfy the special needs of non-IBM engineers who wish to attach the processing unit of the IBM 1401 Data Processing System to their equipment. It provides easy access to supplemental tie-in data not as readily available in other IBM publications.

Detailed theory of operation and mechanical principles of operation are not included. These can be found in the IBM customer engineering manual of instruction

for the 1401 system. Additional engineering information can be had from systems logic diagrams and other engineering documents available.

Additional details relating to operation and use of the 1401 can be found in IBM reference manuals describing data processing systems and in customer engineering manuals for units attached to the 1401, or systems using the 1401.

Functional Characteristics

The IBM 1401 Processing Unit (Figure 1) is a completely transistorized, high-speed, advanced data processing machine.

No control panels are used in the 1401. Operation is controlled entirely by stored programming. A program routine is stored in the core storage unit before processing begins. Processing then proceeds, step by step, through the stored program routine, analyzing each instruction and performing the function called for before going to the next instruction.

Core Storage

Storage capacity is 1,400, 2,000, 4,000, 8,000, 12,000, or 16,000 alphanumerical characters of 8-bit core storage. The eight bits consist of six bits for the alphanumerical binary code, one bit for the word mark used to define word length, and one bit for the odd-redundancy parity check.

Core storage operates serially on an 11.5-microsecond storage cycle. This normally consists of 3 microseconds for storage read out, 3.5 microseconds for data manipulation, and 5 microseconds for data regeneration.

All storage positions are addressable. Each position is identified by a 3-character address. The first 1,000 positions of storage have the addresses 000-999. The next 3,000 positions use an alphabetic or special character in the hundreds position of the address.

The 12,000 additional core-storage locations are addressed by the presence of zone bits located over the units position of each storage address over 3,999. These zone bits are added to the basic 4,000-character coding system.

The IBM 1401 addresses core storage locations by assigning a digit value to each bit that appears over the hundreds and units position of the 3-character address.

Instruction Format

Variable word-length instructions are used in the 1401. Instruction length can vary from one to eight characters.

Op	(A/I)	(B)	d
X	XXX	XXX	X

Op is a 1-character operation code that defines the basic instruction. The Op-code position must also con-

ACTUAL ADDRESSES	ZONE BITS OVER HUNDREDS POSITION	ZONE BITS OVER UNITS POSITION	3-CHARACTER ADDRESSES
0000 to 0999	No Zone Bits	No Zone Bits	000 to 999
1000 to 1999	A-Bit (Zero-Zone)	No Zone Bits	+00 to Z99
2000 to 2999	B-Bit (11-Zone)	No Zone Bits	$\bar{0}00$ to R99
3000 to 3999	AB-Bits (12-Zone)	No Zone Bits	$\bar{0}00$ to I99
4000 to 4999	No Zone Bits	A-Bit (Zero-Zone)	00+ to 99Z
5000 to 5999	A-Bit (Zero-Zone)	A-Bit (Zero-Zone)	+0+ to Z9Z
6000 to 6999	B-Bit (11-Zone)	A-Bit (Zero-Zone)	$\bar{0}0+$ to R9Z
7000 to 7999	AB-Bits (12-Zone)	A-Bit (Zero-Zone)	$\bar{0}0+$ to I9Z
8000 to 8999	No Zone Bits	B-Bit (11-Zone)	00 $\bar{0}$ to 99R
9000 to 9999	A-Bit (Zero-Zone)	B-Bit (11-Zone)	+0 $\bar{0}$ to Z9R
10000 to 10999	B-Bit (11-Zone)	B-Bit (11-Zone)	$\bar{0}0\bar{0}$ to R9R
11000 to 11999	AB-Bits (12-Zone)	B-Bit (11-Zone)	$\bar{0}0\bar{0}$ to I9R
12000 to 12999	No Zone Bits	AB-Bits (12-Zone)	00 $\bar{0}$ to 99I
13000 to 13999	A-Bit (Zero-Zone)	AB-Bits (12-Zone)	+0 $\bar{0}$ to Z9I
14000 to 14999	B-Bit (11-Zone)	AB-Bits (12-Zone)	$\bar{0}0\bar{0}$ to R9I
15000 to 15999	AB-Bits (12-Zone)	AB-Bits (12-Zone)	$\bar{0}0\bar{0}$ to I9I

Figure 2. IBM 1401 Addressing System

tain a word mark. (This word mark is set under program control.)

(A/I) is a 3-character storage address. A is the address of a data word in the A-field. I is the address of the next instruction to be executed if a branch occurs.

(B) is a 3-character storage address of a data word in the B-field. The d is a 1-character modifier to the operation code.

The variable-length instructions can take six different forms. Figure 3 shows examples of these six possible combinations.

A- and B-Registers

These registers are single-character storage devices used for storing the specific characters being treated. The single-character storage output enters the B-register in parallel from the cores. The A-register can receive one character at a time from the B-register. Characters thus stored may be added, subtracted, compared, or otherwise treated. Information can be written back into storage from either register.

Address Registers

There are three 3-digit address registers:

1. I-address register contains the location of the next

instruction character to be used by the stored program.

2. A-address register contains the storage location of the data in the (A) portion of an instruction.
3. B-address register contains the storage location of the data in the (B) portion of an instruction

NUMBER OF POSITIONS	OPERATION	INSTRUCTION FORMAT
1	Read	Op <u>1</u>
2	Stacker Select	Op d <u>K</u> 2
4	Branch Unconditional	Op (I) <u>B</u> 400
5	Branch Unequal	Op (I) d <u>B</u> 625 /
7	Add	Op (A) (B) <u>A</u> 072 423
8	Test Character and Branch	Op (I) (B) d <u>B</u> 650 080 4

Figure 3. Instruction Formats

Word Mark

The use of variable-length instruction and data format requires some means for determining the instruction and data word length. A word mark serves this purpose. The word mark indicates data word size. It also indicates read in completion of the preceding instruction, causing the beginning of an execution cycle.

Rules governing word mark use are:

1. Word marks are not moved with data, except when a `LOAD` instruction is used.
2. When moving data from one location to another, only one field requires a defining word mark, because a `MOVE` instruction implies that both fields are the same length. If the fields are of different lengths, the first word mark encountered defines the length of both fields and stops the operation.
3. For an arithmetic operation, the B-field must have a defining word mark. The A-field must have a word mark only when it is shorter than the B-field.
4. A `LOAD` instruction moves the A-field word mark to the B-field, and clears any other word marks in the B-field up to the length of the A-field.
5. A word mark must be located in the high-order character (operation code) of each instruction.
6. Two operation codes are provided to permit setting and clearing word marks.

Checking

All data processed in the 1401 is parity checked at various locations; that is, checked to see that an odd number of bits exist in a character. Parity checks are

made of the A- and B-registers, the inhibit lines (storage check), the Op-register and the storage-address register.

Characters are also validity checked when read into storage; that is, checked to insure that only valid characters are entered into storage. This checks the bit configuration representing each character in storage.

Additionally, a hole-count check is available when card equipment is used with the 1401. This counts the number of holes in each column of each card, to establish that it is equal to the number of holes called for in the same card at the previous read or punch station.

Input/Output Attachment

The input/output attachment circuitry and cable connection to the 1401 allows an input/output unit to be attached to the 1401 without requiring further modifications to the 1401 circuitry.

The I/O unit must be attached to the 1401 so that an exchange of signals between the two is possible. The data lines accept one character at a time, utilizing a 7-bit BCD code plus a word-mark bit if required. The character rate can be any value up to a maximum of 86 kc. The exact character rate depends on the characteristics of the device attached to the 1401. The input/output unit controls the 1401 clock after the I/O unit has been instructed to read or write. The 1401 is locked up between characters.

It is required that each I/O unit have at least a one-character register (or equivalent) to which a character can be sent or from which a character can be received.

Physical Characteristics

Console

Keys and Switches

Console keys and switches are shown in Figure 4.

POWER ON

Pressing this key turns power on in the system and causes the power on key to light. It also causes all control triggers and latches to be reset, and turns on the `DELTA 1` cycle latch.

POWER OFF

Pressing this key turns power off in the system.

START RESET

This switch resets all control triggers and latches in the system, and turns on the `DELTA 1` cycle latch.

I/O CHECK STOP

When in the `ON` position (up), the 1401 stops at the completion of an I/O operation if an error occurs during that operation. When in the `OFF` position, the 1401 will not stop automatically after an I/O error detection. With the switch in the `OFF` position, error detection must be accomplished by programming.

START

This key is used to initiate or resume machine operation following a manual, programmed, or automatic stop. Keys serving the same function are normally

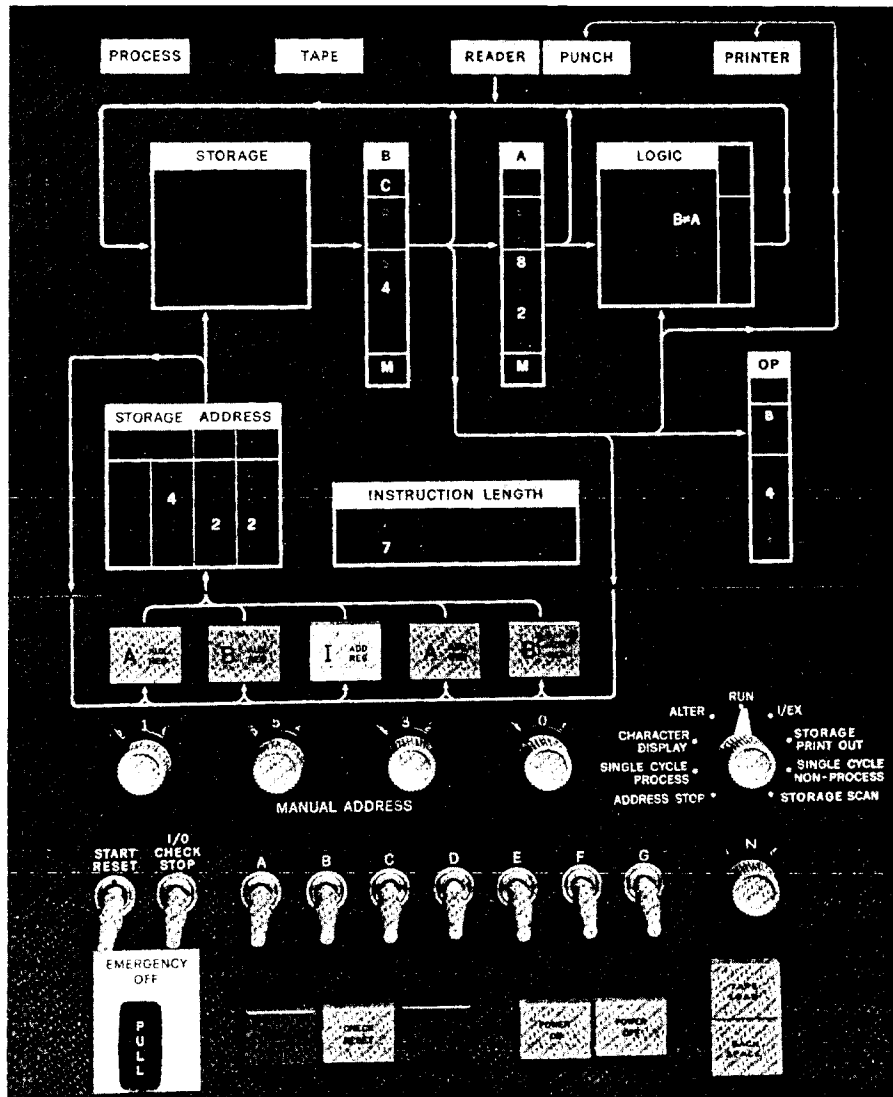

Figure 4. IBM 1401 Console

found on the I/O units within the system. Operation of this key is conditioned by several modes:

1. During a normal RUN mode, the system can be started by pressing the start key on any of the units.
2. During a SINGLE CYCLE PROCESS mode, any of the start keys can cause the system to advance through an instruction (except for I/O instructions) one cycle at a time. For I/O instructions, the system advances through the instruction portion one cycle at a time, but goes through the execute portion at high speed.
3. To restart following an error indication, the check reset key must be pressed before operation of the start key.

4. Following a card jam or misfeed in the card I/O equipment, the cards in the associated feed must be run out by means of the non-process runout key for that feed, and the hopper must be reloaded before pressing the start key.

STOP

This is a lighted key, and is used to stop processing in the system manually. When in the RUN mode, however, it does not take effect until the instruction being executed has been completed.

EMERGENCY OFF

This is a pull switch. Pulling this switch disconnects all power to the entire system. The switch must be manually reset by a qualified technician before power can again be applied to the system.

CHECK RESET

An error detection by the checking circuits causes this key to light. It must be pressed following a 1401 error, before the start key can be effective.

I-ADDRESS REGISTER

When this key is lit, it indicates that the I-address register was the last address register to address storage and that the storage address display is displaying the I-address register contents. When the light is off, pressing this key causes it to glow and causes the contents to be displayed by the storage address display.

A-ADDRESS REGISTER

This key operates the same as the I-address register key, but for the A-address register.

B-ADDRESS REGISTER

This operates the same as the I-address register key, but for the B-address register.

MANUAL ADDRESS

These four switches are used to select the address to be entered in the storage address register. From left to right, the switch positions are: thousands, hundreds, tens, units.

These switches are also used to select a storage location for a display or alteration, without disturbing the contents of the address registers.

SENSE SWITCHES

Seven sense switches can be included in the IBM 1401. Switch A is standard in most systems; the other six (B, C, D, E, F, and G) are optional. Switch A is used to control last card operations by making the TEST AND BRANCH instruction effective only when the last card in the reader has passed the second read brushes.

MODE SWITCH

The nine-position mode switch selects the nine modes of operation.

Run: This is the normal mode of operation in which the machine is under control of the stored program.

I/EX (Instruction /Execution): When the mode switch is in this position, the first time the start key is pressed, the machine reads one complete instruction from storage and stops. This is the I (instruction) phase. The next pressing of the start key allows the machine to perform the execution of that instruction.

Single Cycle Process: When set for this mode of operation, each pressing of the start key causes the machine to take one 11.5-microsecond storage cycle, and to advance through the instruction and execution portions of the program one character at a time.

Single Cycle Non-Process: This mode of operation is similar to the SINGLE CYCLE PROCESS mode, except that no data is allowed to enter storage from the A-register or the logic unit. This mode permits observing the results of arithmetic operations, one character at a time, in the logic display without destroying the original B-field data.

Character Display: When operating in this mode, pressing the start key causes a character at an address in storage (selected by the manual address switches) to be displayed in the B-register.

Storage Print-Out: This mode of operation permits any 100-character block of storage to be printed. The hundreds and thousands manual address switches are used to select the desired block of storage.

Alter: This mode of operation permits the operator manually to change the contents of any address register or storage location.

Storage Scan: When in this mode, pressing the start key causes the 1401 to start reading out of storage beginning at the address set in the manual address switches. If any error condition is detected that had been previously set by the 1401 process unit or by an input/output device, the machine stops, and the check lights in the process unit and the corresponding input/output unit turn on. The storage address display unit shows the location of the error. The B-register contains the storage position in which the error was detected. Using the bit switches and enter key corrects the actual location in storage. After the error condition is corrected, the mode switch is again set to STORAGE SCAN. Pressing the start key again causes a read-out of storage beginning at the address set in the manual address switches, and continuing to the end of storage if no other errors exist.

Address Stop: In this mode, pressing the start key starts the program and the machine stops at the address selected by the manual address switches.

TAPE SELECT SWITCH

This rotary switch is set to the normal position (N) during automatic operation. The switch can be set to the numbers (1-6) that correspond to any of the attached tape units, when manual operation is desired.

D-position is a diagnostic position of the switch. The D-position controls tapes from memory the same as the N-position. D-position permits an error to be retained in A and B skew register on the customer engineering diagnostic panel when the error stop switch is ON.

BACKSPACE KEY

This key works in conjunction with the tape select switch. When the switch is set to a specific tape unit, pressing this key causes the tape in the selected unit to backspace over one group of records until an inter-record gap is sensed.

TAPE LOAD KEY

When this key is pressed, tape unit 1 is automatically selected and tape data starts loading at address 001 and continues until an inter-record gap is sensed.

Lights

Console lights are shown in Figure 4.

PROCESS, READER, PUNCH, PRINTER, AND TAPE

When the machine stops because of an error, one of these lights will glow red to indicate the source of the error.

STORAGE

This light glows red when a parity check detects an error at the input to storage.

B-LIGHT

This light glows red when a B-register parity check occurs. The lights underneath display the coded character, check-bit status, and the word mark status of the character in the B-register.

A-LIGHT

This light glows red when an A-register parity check occurs. The lights underneath display the coded character, check-bit status and the word mark status of the character in the A-register.

LOGIC LIGHTS

O-Fl: This light glows when an overflow condition exists.

$B \neq A$: This light glows when an unequal-compare condition exists after a COMPARE instruction. Additional lights are provided for high-low-equal compare when this feature is included in the system.

BIT DISPLAY

Displays the bit configuration of the characters being processed in the arithmetic section.

OP-REGISTER

The Op light glows red when an incorrect operation code exists in the Op-register, or if the code is incorrectly decoded. The lights underneath indicate the coded character and check-bit status of the character in the Op-register.

STORAGE ADDRESS

This light glows red when an address register parity check or validity check occurs. The lights underneath indicate the four coded characters and the check-bit status of the characters in the storage-address register.

INSTRUCTION LENGTH

These lights indicate the number of characters in the instruction.

Auxiliary Console

Keys, Switches and Lights

Figure 5 shows auxiliary console keys, switches, and lights.

BIT SWITCHES

Eight bit switches are available for use in altering a character in storage. These switches set the bit structure of the required character when the mode switch is in the ALTER position (see *Mode Switch: Alter*).

ENTER

Pressing this key, with the mode switch set to ALTER, enters the character determined by the bit switches into a position in storage.

I/O CHECK RESET

Pressing this switch, with the I/O check stop switch in the OFF position, resets the I/O error latches.

PROCESS CHECK STOP

This switch is normally on, causing the machine to stop automatically when a process check occurs. When in the OFF position, the machine does not stop on process checks, except for Op-register and address-register checks.

READ INTERLOCK

With this light off, the reader is interlocked until the print operation is complete. When on, the reader is in a ready condition.

PUNCH INTERLOCK

When this light is off, the punch is interlocked until completion of the print operation. When this light is on, the punch is in a ready condition.

PRINTER DISPLAY

This light is on when a print operation is being executed.

RUN

When this light is on, the printer is in a ready condition. When this light is off, the printer is interlocked until completion of the print operation.

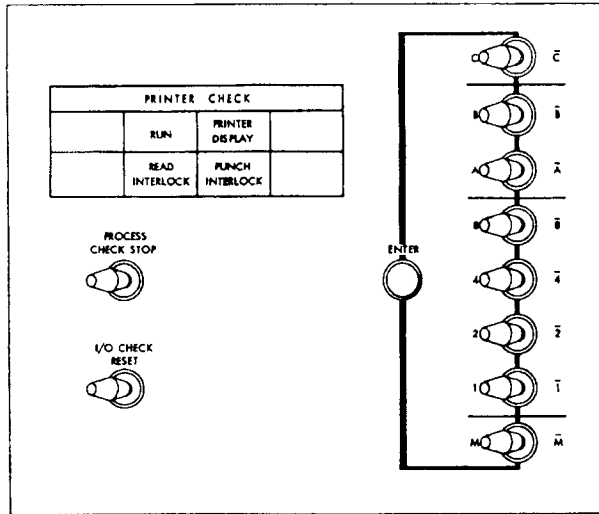

Figure 5. IBM 1401 Auxiliary Console

Customer Engineering Diagnostic Panel

The customer engineering diagnostic panel (Figure 6) is operative with the tape unit select switch. This switch on the 1401 console *must* have the correct unit selected when the diagnostic panel is used.

Indicator Lights

DELAY COUNTER

These lights indicate the setting of the delay counter.

RC

This light indicates that the read condition latch is on.

RD

This light indicates that the read delay latch is on.

RDD

This light indicates that the read disconnect delay latch is on.

R

This light indicates that the read only latch is on.

WC

This light indicates that the write condition latch is on.

WD

This light indicates that the write delay latch is on.

WDD

This light indicates that the write disconnect delay latch is on.

w

This light indicates that the write latch is on.

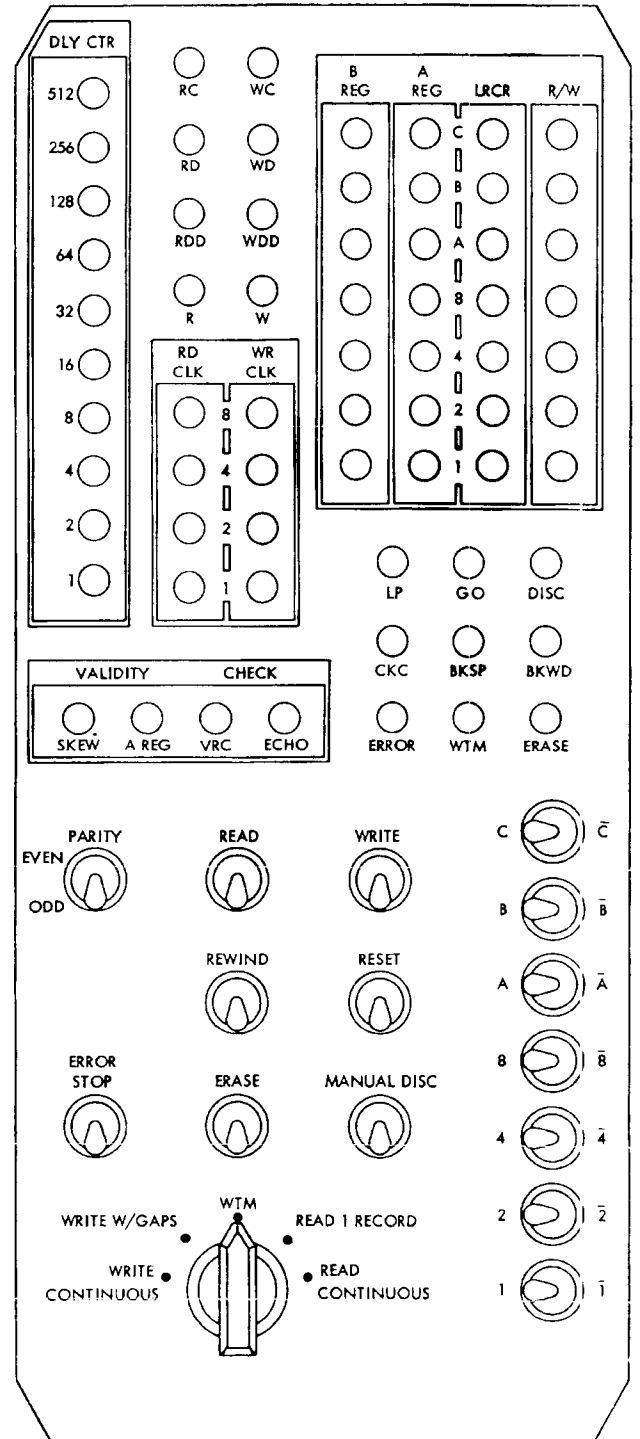

Figure 6. Customer Engineering Diagnostic Panel

READ CLOCK-WRITE CLOCK

These lights indicate the read and write clock settings.

B REG

These lights indicate the character that is in the B-register.

A REG

These lights indicate the character that is in the A-register.

LRCR

These lights indicate which longitudinal redundancy check register (LRCR) triggers are on.

R/W

These lights indicate the character that is in the read/write register.

VALIDITY CHECK

Skew: This light indicates that the skew error latch is on.

A Reg: This light indicates an error in read register A.

VRC: This light indicates a vertical redundancy error in the R/W register.

Echo: This light indicates that the echo error latch is on.

LP

This light indicates that a tape unit is at load point (LP latch on). It will not go off until the end of a read or write operation.

GO

This light indicates that the GO latch is on.

DISC

This light indicates that the disconnect latch is on.

CKC

This light indicates that the check character latch is on.

BKSP

This light indicates that the backspace latch is on.

BKWD

This light indicates that the backward latch is on.

ERROR

This light indicates that the TAU error latch is on.

WTM

This light indicates that the write tape mark latch is on.

ERASE

This light indicates that the erase latch is on.

Switches

See Figure 6.

PARITY (EVEN-ODD)

This switch activates and controls parity checking.

READ

This switch starts read operation on either read continuous or read one record.

WRITE

This switch starts write operation on write continuous, write with gaps or write tape mark operations.

REWIND

This switch rewinds the tape to load point.

RESET

This switch stops operations immediately. It also resets error conditions.

ERROR STOP

When this switch is ON, it stops machine on error condition. When this switch is OFF, the error light comes on but machine continues to operate.

ERASE

This switch turns on erase latch in TAU. Erase takes place on next write operation.

MANUAL DISCONNECT

This switch, when ON for read operation, causes machine to stop at the end of the record.

When ON for write operation the machine stops writing immediately.

FUNCTION SELECT SWITCH (5-POSITION)

Write Continuous: The select switch in this position sets up conditions to write tape continuously. The write switch must be operated to start writing.

Write with Gaps: The select switch is set in this position for writing short records.

Write Tape Mark: With the select switch in this position, one tape mark is written each time the write switch is operated.

Read One Record: With READ ONE RECORD selected, one record is read each time the read switch is operated.

Read Continuous: With READ CONTINUOUS selected and the read switch operated, the machine reads tape until it is stopped by MANUAL DISCONNECT or RESET.

BIT SWITCHES: 1, 2, 4, 8, A, B, C

These seven switches control the corresponding bit lines.

Power Requirements

The IBM 1401 requires a 3-phase, 208/230-volt, ac source of voltage. The mainline voltage is fed through circuit breakers and a contactor to two ferroresonant regulators, a step-down transformer, and a -60-volt supply. In stage II systems, the mainline voltage is also fed to the ± 3 -volt marginal check supply.

The IBM 1401 models A, B, C, E, and F are used in systems that also include the IBM 1402 Card Read-Punch. For all five models, the main contactors, circuit breakers, 1250-watt ferroresonant regulator, step-down isolation transformers, -20-volt supply, -60-volt supply, and the ± 3 -volt marginal check supply are located in the IBM 1402 Card Read-Punch. When the 1401 is desired individually, the 1401 model D must be utilized because it contains all the previously-mentioned components.

The 1401 models B, C, D, E, and F also contain a 585-watt ferroresonant regulator to supply regulated ac to additional SMS (Standard Modular System) power supply assemblies required in these models.

The 1250-watt regulator provides power to the following 1401 model supplies:

- 6 v dc at 12 amps
- +6 v dc at 16 amps
- 12 v dc at 20 amps
- 20 v dc at 15 amps
 - (-20 v dc at 6 amps for model D)
- 30 v dc at 4 amps
 - (+30 v dc at 7 amps for stage II machines)
- ± 3 v MC supply
 - (stage I machines only)

Signal Levels

Complemented transistor diode logic (CTDL) levels are used in the IBM 1401. These are either +T (+6 volts) or -T (-6 volts) with a ground reference; or +U (ground) or -U (-12 volts) with a -6-volt reference.

A line driver (Figure 7) IBM part number 370089, is used to drive all 1401 output lines to the attached I/O unit. This line driver has a +U input and a -C current output signal. The -C current output serves as an input to a line terminator, IBM part number 370145, or other compatible terminator located in the I/O unit.

A +12-volt dc is developed from the +30-volt supply. A transistor-emitter follower circuit is used to maintain a constant output voltage. A potentiometer in the voltage divider network can be used to raise or lower the output voltage.

A +18-volt differential (stage II machines only) is developed from the +30-volt supply. The output voltage of this supply is maintained at 18 volts less than the output of the +30-volt supply. A potentiometer in the voltage divider network is used to adjust for the 18-volt difference.

The 585-watt regulator provides power to the following 1401 model B, C, and D supplies:

- +6 v dc at 12 amps
- 6 v dc at 8 amps
- 12 v dc at 12 amps
- 36 v dc at 2 amps

A self-contained unit provides for the printer:

- 60 v dc at 10 amps

The portion of the +6-volt and -12-volt output that controls transistor base circuitry is distributed, through a switching assembly to the proper pins of the SMS card sockets. By proper manipulation of the MC switches, the +6m or -12m voltages may be varied by the marginal check unit.

In addition to the preceding, mainline voltage is also furnished through a separate contactor to a step-down transformer that supplies 115-volt ac to the service outlets and blower motors.

C level is essentially a current shift between driver and terminator in which the negative shift is considered the ON or logical one condition. C level swings around a ground reference from a +6-volt up level to a -5-volt down level. Maximum permissible ground shift between driver and terminator is $\pm \frac{1}{4}$ volt. The line driver output is a C signal level.

Transmission lines of 93-ohms impedance (range 91 ohms to 105 ohms) are required between driver and terminator. These can be either twisted pair or coaxial.

Conversely, lines originating in the I/O unit and serving as inputs to the 1401 must use the same (or compatible) line driver as the 1401, because the 1401 also uses the previously mentioned line terminator.

Input/Output Signal Lines

IBM 1401 Output Lines to the I/O Unit

All the following are not necessarily used by any one machine. They are connected as needed to perform the desired functions. The cable reference number is 02TD. Plug connector location conforms to the following convention: 02TD-121 (signal wire)/122 (reference wire).

PC—059/060 —C 1401 is Stopped

This line has a -C level when the delta process latch in the 1401 is off, and the 1401 is not executing an I/O operation. This is an indication to the I/O unit that the 1401 has been stopped by:

1. executing a stop instruction
2. pressing the stop key in the 1401
3. automatically stopping on an error condition.

PC—084/085 —C 1401 Not Start Reset

This line has a -C level or a +C level at all times except when the 1401 start reset key is pressed. The I/O unit determines which level is desired and cable connectors should be wired accordingly.

PC—095/105 —C I/O Process Check

This line is at a -C level when a process check (B-register, A-register, arithmetic, inhibit, Op-register, or star error) exists in the 1401. This line can be used to stop the I/O unit. It notifies the I/O unit that the 1401 will stop at the completion of the I/O operation. If not in an I/O operation, it means that the 1401 is stopped with an error.

PC—101/102 —C I/O Time 000-030

This line is at a -C level from 000-030 time of every 1401 clock cycle.

PC—103/104 —C I/O Time 030-060

This line is at a -C level from 030-060 time of every 1401 clock cycle.

PC—110/120 —C Reset Transmission Error Latch

This line will have a -C level from 090-000 time of one cycle on a BRANCH ON I/O TRANSFER 1 (error) instruction if the I/O transfer 1 line is at a -C level.

PC—115/125 —C Select I/O Attachment

This line is at a -C level when the 1401 is executing an instruction selecting the I/O unit. At all other times

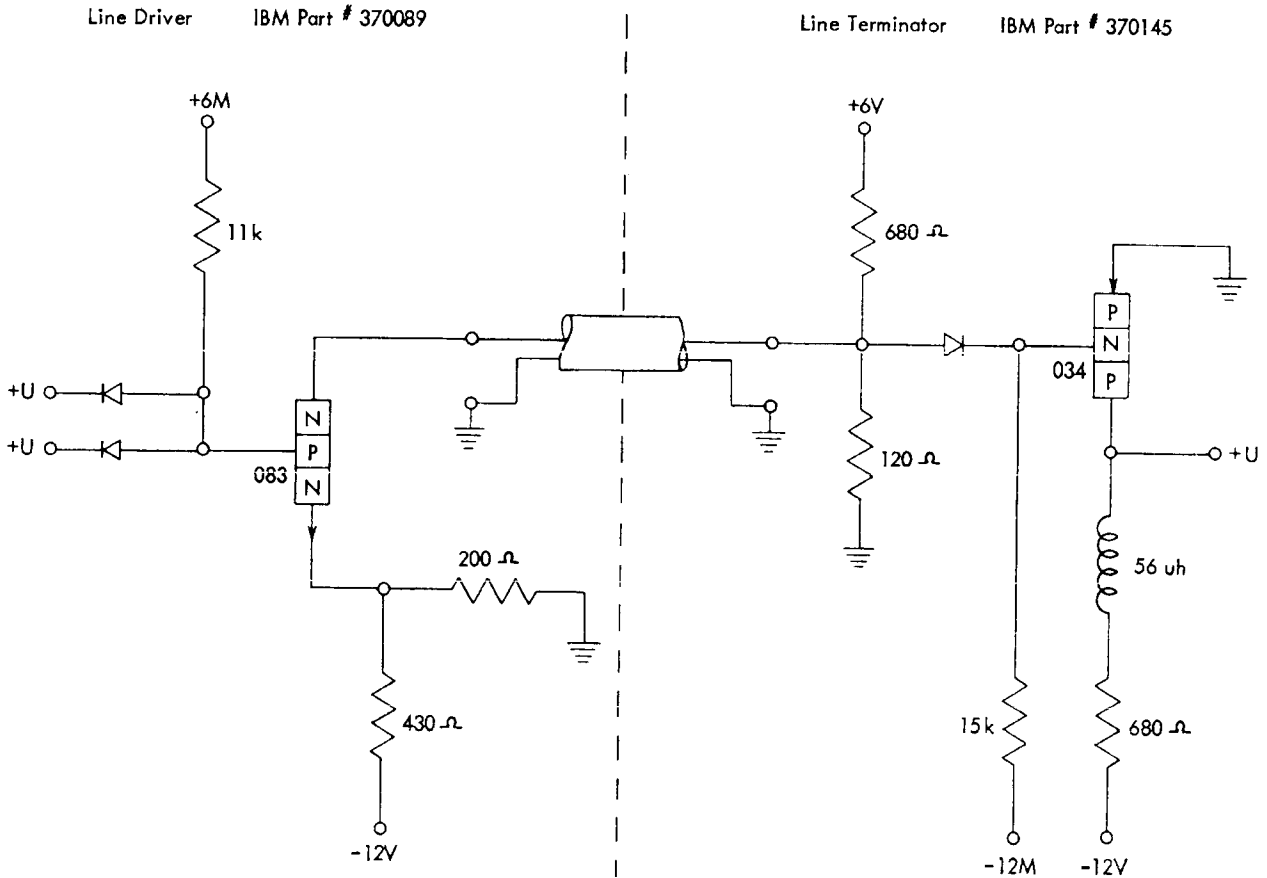

Figure 7. Line Driver and Terminator

this line is at +C. This line comes on at 090 time of I-ring 2 of the I/O instruction, and remains on until I-ring Op time of the next instruction.

PC—119/118 --C Service Response

This line has a --C level from 030 time until the turn on of the service request line, or until the turn off of the service request line, if so required during an I/O read call. It also has a -C level from 075 time until the turn on of the service request line, or until the turn off of the service request line, if so required during an I/O write call. This line signals the I/O unit that the 1401 has taken the input data when the 1401 is reading, or that the 1401 data is available to the I/O unit when the 1401 is writing.

PC—121/122 --C I/O Attachment Write Call

This line has a -C level when the 1401 is ready and waiting to write and when it is sending data to the I/O unit. This line comes on at 090 time of the last I cycle of a MOVE or LOAD instruction and remains on until I time of the next instruction.

PC—123/124 --C I/O Attachment Read Call

This line has a -C level when the 1401 is ready and waiting to read, and when it is reading data from the I/O unit. This line comes on at 090 time of the last I cycle of a MOVE or LOAD instruction and remains on until I time of the next instruction.

PC—126/127 --C I/O Time 090-000

This line is at a --C level from 090-000 time of every 1401 clock cycle.

PC—136/137 --C I/O Disconnect

This line is -C when the 1401 reads a group-mark, work-mark from storage when the select I/O attachment line is on. This causes the 1401 to stop writing or reading and advance to the next instruction. This signal is an indication to the I/O device that the transmission of data is completed as far as the 1401 is concerned, and the next instruction is now executed. For certain I/O units this becomes a dc level that must be reset by the I/O transfer 5 line from the I/O unit. This wiring is accomplished in the cable connector.

--C I/O Select Lines

There are a maximum of 16 I/O select lines that are available to send signals to the I/O unit.

The select lines 1 through 14 are controlled by the stacker select (K) Op code with modifier characters A through N.

The last two select lines, I/O unit 1 control and I/O unit 2 control, are controlled by the unit control (U)

Op code that selects the I/O unit and has modifier characters E and D respectively.

PC#	Active when following instruction is executed	Line
142/141	KA	-C I/O 1 Select
144/143	KB	-C I/O 2 Select
146/145	KC	-C I/O 3 Select
148/147	KD	-C I/O 4 Select
150/149	KE	-C I/O 5 Select
152/151	KF	-C I/O 6 Select
154/153	KG	-C I/O 7 Select
140/155	KH	-C I/O 8 Select
138/139	KI	-C I/O 9 Select
156/157	KJ	-C I/O 10 Select
158/159	KK	-C I/O 11 Select
160/161	KL	-C I/O 12 Select
162/163	KM	-C I/O 13 Select
130/131	KN	-C I/O 14 Select
164/165	U (AAA) E	-C I/O Unit 1 Control
166/167	U (AAA) D	-C I/O Unit 2 Control

--C I/O Output Lines

There are seven I/O output data lines from the IBM 1401. They consist of the 6-bit BCD code plus a check bit. These lines have a --C level from 060 time to 090 time, when they contain information and the 1401 I/O write call line is on. These lines are fed from the B-register in the 1401. The B-register is reset from 000-015 time and set from 000-030 time. The information can be taken from the I/O output lines by the I/C unit after 060 time of a 1401 cycle.

PC#	Line
186/187	-C I/O Output 1
188/189	-C I/O Output 2
190/191	-C I/O Output 4
192/193	-C I/O Output 8
194/195	-C I/O Output A
196/197	-C I/O Output B
198/199	-C I/O Output C

The following output lines go to the 200-position connector located in the 1401, but these lines *do not* have cable drivers connected to them. These lines are intended to be used for completing circuits within the 1401 by jumpering through the cable connector that is connected into the 1401. The jumpering must be located immediately inside this connector and cannot be done in the I/O unit itself.

The first ten lines described here are to be used to enable the 1401 to select the proper I/O device connected to it. The selected address of the device takes the form of:

% N 1

The character U can be any of the following characters:

A	K	S
D	O	V
E	P	W
G	Q	X
H	R	Y
I		Z

The other alphanumerical characters not listed in the preceding are used by other devices that do not necessarily use the I/O adapter.

The character that selects the I/O unit is located in the A-register at I ring 2 time and these lines must be jumpered in the I/O cable connector to correctly select the device as follows:

PC—017	+U A-Reg AB
PC—018	+U A-Reg A Not B
PC—031	+U A-Reg B Not A

One of the preceding 3 lines must be jumpered to the input line +U A-Reg Sel 1 (001).

PC—044	+U A-Reg 12
PC—016	+U A-Reg Not 12
PC—035	+U A-Reg 1 Not 2
PC—032	+U A-Reg 2 Not 1

One of the preceding 4 lines must be jumpered to the input line +U A-Reg Sel 2 (002).

PC—033	+U A-Reg Not 48
PC—034	+U A-Reg 4 Not 8
PC—045	+U A-Reg 8 Not 4

One of the preceding 3 lines must be jumpered to the input line +U A-Reg Sel 3 (003).

PC—019 -T Force Odd Red 1-Out

If the I/O unit is sending or receiving data that has an odd-redundancy parity, then this line must be jumpered to the input line -T Force Odd Red PC—004.

PC—020 -T Inhibit WM 1

If the I/O input WM line from the I/O unit is being used, this line must be jumpered to the input line -T Inhibit WM (005).

PC—021 +U Not I/O Read Call 1

If the I/O unit is sending data from low order to high order, it will require the B-star to modify by minus one, therefore, this line must be jumpered to +U Not I/O Read Call (006).

PC—022 -T Set Re-address Latch 1

If the I/O unit is using I/O re-address input line, then this line must be jumpered to the input line -T Set Re-address Latch (007), gated with 030-060 time.

PC—023 -T Reset A-Reg Error 1

When it is desired that the I/O unit reset the A-register error if a transmission error occurs, then this line must be connected to -T Reset A-Reg Error (008).

PC—013 -T I/O Trans 1

If the I/O unit requires that the I/O Trans 1 input line is to cause an end-of-transmission condition to occur

in the 1401 during an I/O read or write operation, then this line must be jumpered to the input line -T I/O Trans EOR (012).

PC—027 -T I/O Trans 2

If the I/O unit requires that the I/O Trans 2 input line is to cause an end-of-transmission condition to occur in the 1401 during an I/O read or write operation, then this line must be jumpered to the input line -T I/O Trans EOR (012).

PC—036 +6 Volts

This line must be jumpered to the input line -T I/O Trans EOR, if neither one of the preceding two lines (-T I/O Trans 1 or -T I/O Trans 2) are connected to it.

PC—014 +U I/O Disc Out 1

If the I/O unit requires a six-microsecond pulse for a disconnect signal, the line must be jumpered to +U I/O Disc In (030).

PC—015 +U I/O Disc Out 2

If the I/O unit requires a dc level for a disconnect signal, the line must be jumpered to +U I/O Disc In (location already stated). (It must be remembered that if this condition exists, the I/O Transfer 5 line must be used to reset the I/O disc latch.)

PC—028 +U Select 1 Out

If the I/O unit requires a dc level on the I/O 1 Select line, then this line must be jumpered to +U Select 1 In (029). The I/O Transfer 2 line must be used to reset the I/O 1 select latch.

PC—024 +U Set Write Latch Out

The IBM 1401 can accept a pulse to set a latch and hold the I/O Trans 3 condition if this line is jumpered to the input line +U Set Write Latch In (009).

This latch is reset when the 1401 executes an I/O read call.

PC—039 +U Start Reset Out

If the I/O unit requires an ON signal when the 1401 start reset key is pressed, this line must be jumpered to +U Start Reset In (038).

PC—037 +U Not Start Reset Out

If the I/O unit requires an OFF signal when the 1401 start reset key is pressed (and has an ON signal at all other times), this line must be jumpered to +U Start Reset In (038).

PC—041 +U Service Request Out 1

If the I/O unit requires the 1401 service response trigger to be turned off when the service request input signal to the 1401 is turned on, then this line must be jumpered to +U Service Request In 1 (043).

PC—042 -U Service Request Out 2

If the I/O unit requires the 1401 service response trigger to be turned off when the service request input signal to the 1401 is turned off, then this line must be jumpered to +U Service Request In 1 (043).

PC—046 -T Select I/O Out**PC—047 -T Select I/O In**

These lines must be jumpered for any I/O attachment operation. This sets the I/O select latch.

PC—048 -T Force Odd Red 2

This line must be jumpered to -T Force Odd Red to force an odd redundancy when -C I/O Trans 8 is brought up during an I/O attachment read or write call.

PC—050 -T I/O Write Call In**PC—051 -T I/O Write Call Out**

These lines must be jumpered together to enable the clock to start on the first I-cycle when the attachment write call line is brought up.

I/O Unit — Input Lines to the IBM 1401**PC—057/058 Emergency Off Switch**

Two lines go from the cable connector in the 1401 to the emergency off switch in the 1401. They connect to a normally closed contact on the emergency off switch in such a way that this circuit is open if the emergency off switch is pulled. Otherwise, a completed circuit exists between the two cable connector pins. The I/O unit must use these two pins to connect into their power control circuits. This will enable the 1401 emergency off switch to cut power off in both the I/O unit as well as in the 1401, if this switch is pulled.

PC—082/083 -C Single Character Transmission

This line cannot be brought up before service request comes up. If the I/O unit holds this line at a -C dc level during a read or write operation, the 1401 sends or receives only one character and then goes on to the next instruction. The exception to this is, if during a load operation a word separator is received from the I/O unit or a word separator character is being sent to the I/O unit, then the 1401 sends to or receives from the I/O unit a total of 2 characters.

-C I/O Transfer Lines

From one to eight transfer lines can be sent to the 1401 to be tested by the 1401 stored program, and to cause a program branch. The I/O transfer line 1 is used to indicate an I/O error. All other I/O transfer lines can be used to indicate specific conditions as required by the individual I/O units. The I/O transfer line must be at a -C level during the time the 1401 program executes a test for this particular transfer in order for it to be effective.

PC#	Tested by following instruction	Line
086/087	B(AAA)1	-C I/O Trans 1 (Error)
088/089	B(AAA)2	-C I/O Trans 2
090/100	B(AAA)3	-C I/O Trans 3
097/096	B(AAA)4	-C I/O Trans 4
099/098	B(AAA)5	-C I/O Trans 5
106/107	B(AAA)6	-C I/O Trans 6
108/109	B(AAA)7	-C I/O Trans 7
117/116	B(AAA)8	-C I/O Trans 8

PC—091/092 -C End of Transmission

This line should go to -C to indicate the end of the message being sent to, or being received from, the I/O unit. During an IBM 1401 read operation the I/O unit can bring on this line after it has received the service response signal from the 1401 for the last character that it sent. This line must remain on for a minimum of twelve (12) microseconds to terminate the read operation. During a 1401 write operation, if the I/O unit brings on this line the 1401 stops writing and goes to the next instruction. This line must remain on for a minimum of eighteen (18) microseconds to insure terminating the write operation.

PC—093/094 -C I/O Re-address

When the -C level is available, it sets the re-address latch in the 1401, thus preventing the 1401 from changing its storage-address register. This causes the next storage address to be the same as the last address that was read out of storage. The re-address latch is reset from 030 to 045 time of the 1401 cycle. The latch must be set from 030 to 060 time of the 1401 cycle in which re-addressing is required.

PC—113/114 -C I/O Service Request

This line has a -C level when the I/O unit requires service, that is, if the I/O unit is ready to send a character of information to the IBM 1401, or if it has received a character and is ready to receive the next character.

Turning on this line sets a trigger (if the I/O selecting unit line is on), which is used to start the 1401 clock. This trigger is reset by turning on service response in the 1401 or by turning off the I/O select unit line from the I/O unit. This line must go to +C for a

minimum of two microseconds before this trigger can be set again.

PC—132/133 -C I/O Selecting Unit

This line has a -C level when the I/O unit is either sending or receiving data from the 1401. When the I/O unit turns off this line, the service request trigger in the 1401 is held off and cannot accept a service request signal.

PC—134/135 -C I/O Attention Light

When this line is held at a -C level the EXT I/O light on the IBM 1401 Console lights up, indicating that the I/O unit requires service.

PC—168/169 -C I/O Load

This line is to be held at -C to cause the 1401 to start executing a load instruction and to begin receiving data from the I/O unit. This line is to be used only to start an operation when the power is on in the 1401 but it is not operating, and when the process check is not on. Bringing on this line causes the 1401 to go into an I/O read operation, and to load information into 1401 storage, starting at location 001. At the completion of this read operation, which must be terminated by the I/O unit bringing on the end-of-transmission line, the 1401 transfers to address 001, and executes the instruction located in 001.

The I/O load line must be held ON for a minimum of thirty (30) microseconds and must be turned off before the first character of data is received by the 1401. This line cannot be used unless the 1401 system is a tape system.

-C I/O Input Lines

There are eight I/O input lines into the 1401. They consist of the 6-bit BCD code, a check bit, and a word-mark bit.

PC#	Line
170/185	-C I/O Input WM
172/171	-C I/O Input 1
174/173	-C I/O Input 2
176/175	-C I/O Input 4
178/177	-C I/O Input 8
180/179	-C I/O Input A
182/181	-C I/O Input B
184/183	-C I/O Input C

These lines have a -C level when they contain information to enter the 1401. The 1401 enters this information into its A-register during 000-030 time of a B-cycle when the I/O unit is selected and the I/O attachment read call line is up.

Information relative to signal levels, input/output signal lines, and signal line functions for the IBM 1402 Card Read-Punch, IBM 1403 Printer, and IBM 729 Magnetic Tape Units (as used in the IBM 1401 Data Processing System) is available in OEM manuals for these machines.

For the purpose of this manual, only the 1401 external cable layout (Figure 8) and plug connector locations of the input/output signal and power lines to these machines from the 1401 are illustrated (Figures 9 through 17).

Connector Receptacle Pin Assignments

This section contains diagrams of signal and power connectors from the 1401 process unit to the IBM input-output machines commonly used in the IBM 1401 Data Processing System.

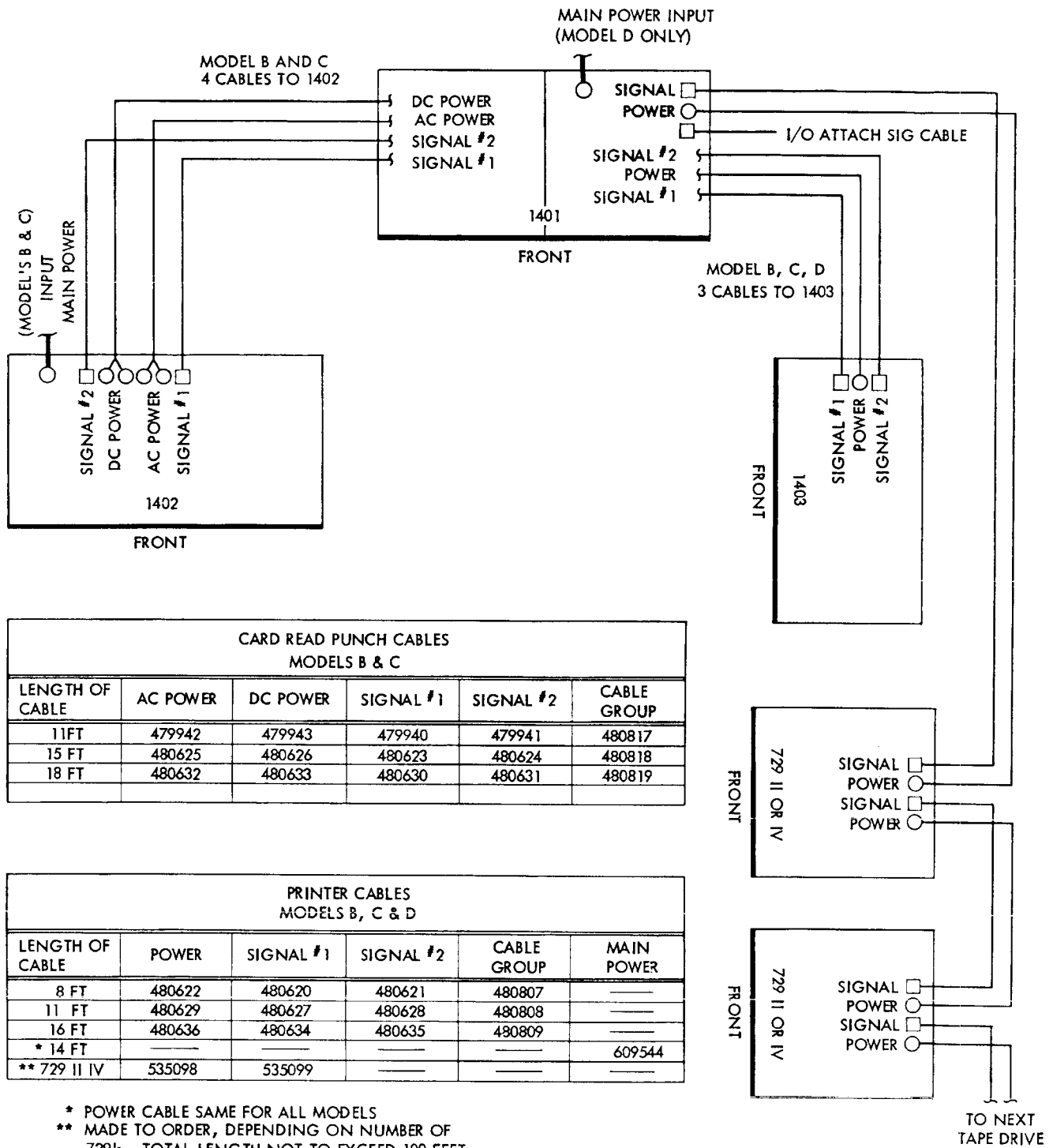

Figure 8. IBM 1401 External Cable Layout

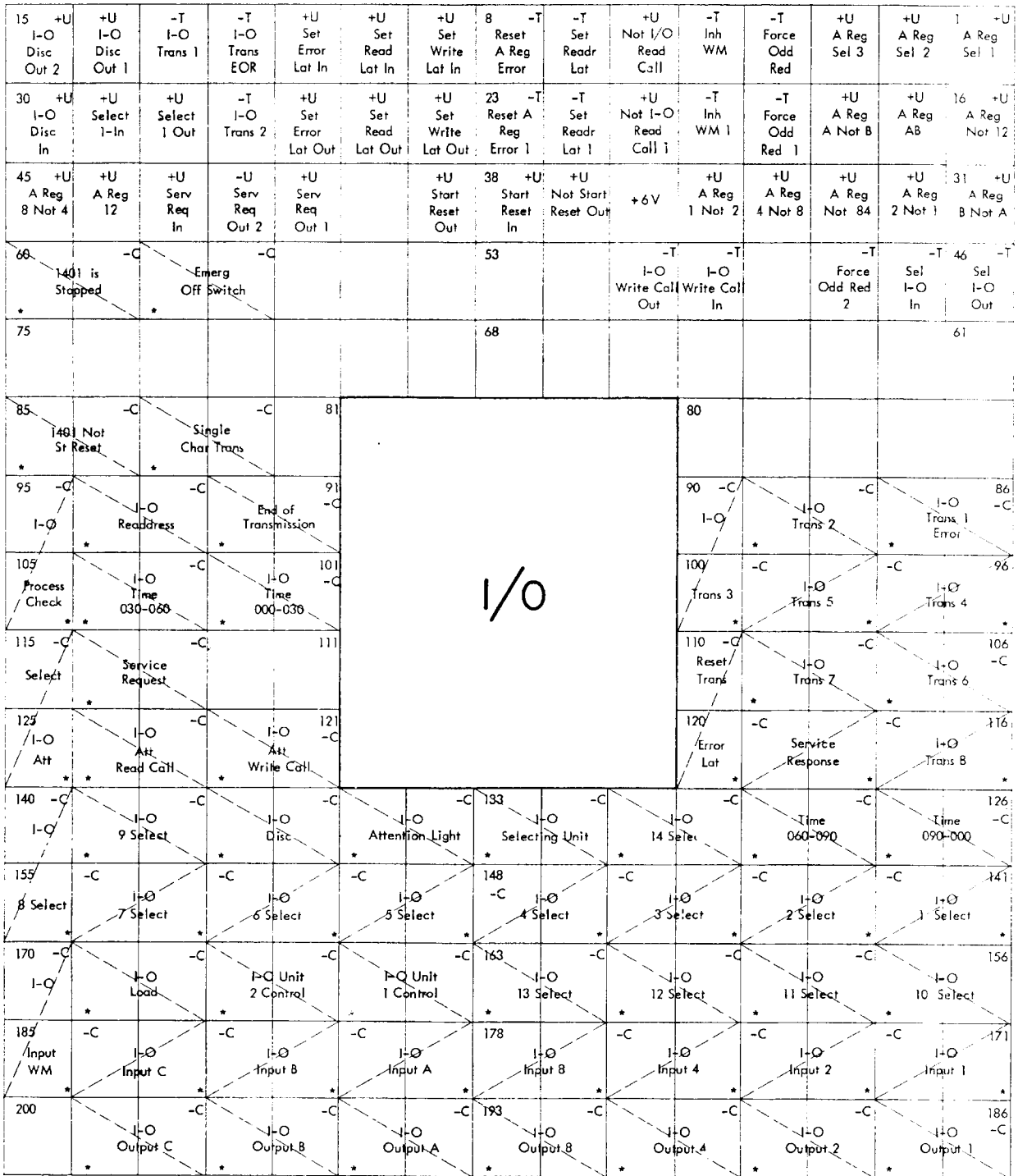

Figure 9. IBM 1401 I/O Attachment Plug Connector Receptacle (Connector Side)

1	+U	+U	+U	+U	+U				8						15							
	PM 1	PM 2	PM 3	PM 4	PM 5																	
16									23						30							
31									38						45							
	Column 1 to 80 Punch Magnets (+U)																					
46									53						60							
61									68						75							
76	+U	+U	+U	+U	80	+U	P/C					81	Punch Brush # 1	Punch Brush # 2	Punch Brush # 3	Punch Brush # 4	85	Punch Brush # 5				
86					90											91						95
96					100											101						105
106					110											111						115
116					120											121						125
126									133								140					
	Column 1 to 80 Punch Brushes																					
141									148								155					
156	Punch Brush # 76	Punch Brush # 77	Punch Brush # 78	Punch Brush # 79	Punch Brush # 80				163								170					
171			-U	-T	-T	-T	-T	-T	178	-T	-T	-T	-T	+T	-T	-T	+U	185	+U			
			Latch Reset	After 9 Cam	Punch Scan CB	Punch Stop	Punch Clutch Magnet	Proc Punch		Not Proc Punch	Punch Jam	Check Reset Punch	Die CL Delay	Stacker Latch Reset	Stack 4	Stack 8						
186	Spare	1/2 Write Punch Brushes	Spare	+U	+U	-T			193									200				
			Stack Inh	Punch Check Light	Start Relay	Spare																

Figure 10. IBM 1401 to IBM 1402 Punch Connector Receptacle (Wiring Side—Fixed Mount)

15											# 1 Read Brush # 5	# 1 Read Brush # 4	# 1 Read Brush # 3	# 1 Read Brush # 2	# 1 Read Brush # 1				
30															16				
45	Connector Pins 1-80 No.1 Read Brushes Col. 1-80														31				
60																46			
75																61			
85 # 2 Read Brush # 5	# 2 Read Brush # 4	# 2 Read Brush # 3	# 2 Read Brush # 2	81 # 2 Read Brush # 1	R/C						80 # 1 Read Brush # 80	# 1 Read Brush # 79	# 1 Read Brush # 78	# 1 Read Brush # 77	76 # 1 Read Brush # 76				
95				91							90								86
105				101							100								96
115				111							110								106
125				121							120								116
140	Connector Pins 81-160 No.2 Read Brushes Col. 1-80														126				
155																141			
170 -T Read Clutch	-T Load Key	-T Read Stop							+T Start Key N/C	160 # 2 Read Brush # 80	# 2 Read Brush # 79	# 2 Read Brush # 78	# 2 Read Brush # 77	156 # 2 Read Brush # 76					
185 +U Stack 2	+U Stack 1	+U Invalid Light	+U Read Check Light	+U 2 CLC	+T Start Key On	-T Stop Key On	178 +T Read Stacker Reset	Spare	-T Last Card	+U Ink Stop	+T Read Check Reset	-T Read Jam	-T Not Proc Feed	171 -T Proc Feed					
200						-T Stack Select	193 Spare	Spare	Spare	1/2 Write # 2 Brush	1/2 Write # 1 Brush	-T Brush Imp CB	-T CB Reset	186 -T Read Comp Gate					

Figure 11. IBM 1401 to IBM 1402 Reader Connector Receptacle (Wiring Side—Fixed Mount)

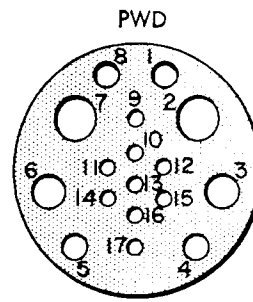
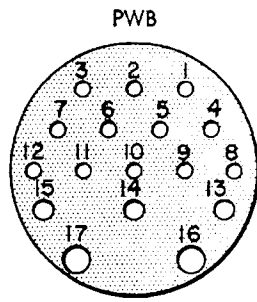

WIRING SIDE

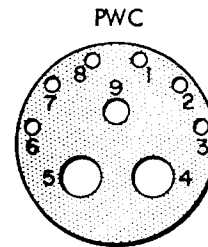
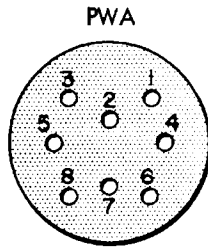

CONNECTOR PWA

CON #	WIRE SIZE	FUNCTION
1	14	133V AC Bulk Supply
2	8	Spare
3	14	133V AC Bulk Supply
4	8	208V AC Ø1 Tape Drive
5	8	208V AC Ø2 Tape Drive
6	14	R/P Frame Ground
7	8	208V Ø3 Tape Drive
8	14	Spare

CONNECTOR PWC

CON #	WIRE SIZE	FUNCTION
1	16	Chain Interlock
2	16	Chain Relay Pick
3	16	-12 Volts DC
4	4	-60V DC Common Ground
5	4	-60V DC Common Ground
6	16	Chain Intlk
7	16	6 Volts DC
8	16	Space Magnet OFF
9	10	-20V Seq-Mem Return

CONNECTOR PWB

CON #	WIRE SIZE	FUNCTION
1	16	3V Control
2	16	3V Control
3	16	Emergency Stop
4	16	Carriage Motors- 208V Ø2
5	16	Carriage Motors- 208V Ø2
6	16	Chain & Rib Mtrs 208V Ø2
7	16	Chain & Rib Mtrs 208V Ø2
8	16	3V Control
9	16	3V Control
10	16	3V Control
11	16	Power On Switch
12	16	Power On Switch
13	14	Spare
14	14	Spare
15	14	Conv Outlets-115V AC
16	10	115V AC Common
17	10	Blowers-115V AC

CONNECTOR PWD

CON #	WIRE SIZE	FUNCTION
1	14	Spare
2	4	-60V Seq Printer Mags
3	8	Marginal Check
4	10	DC Common Ground
5	10	Spare
6	8	Marginal Check
7	4	-60V Seq Printer Mags
8	14	Spare
9	16	-20V Sense Control
10	16	-12 Volt Sense
11	16	Power Hold
12	16	Printer Intlk Ctrl 1
13	16	Printer Intlk Ctrl 2
14	16	Skip Magnet Off Relay Intlk
15	16	Space Magnets
16	16	Control
17	16	Spare

Figure 12. IBM 1401 to IBM 1402 Card Read-Punch Power Plug Pin Assignments

H D = Hammer Drive				H R = Hammer Return				
8	HR 9 & 11	HD 9	HD 7	HR 5 & 7	HD 5	HD 3	HR 1 & 3	HD 1
	HD 21	HD 19	HR 17 & 19	HD 17	HD 15	HR 13 & 15	HD 13	HD 11
	HD 31	HR 29 & 31	HD 29	HD 27	HR 25 & 27	HD 25	HD 23	HR 21 & 23
	HR 41 & 43	HD 41	HD 39	HR 37 & 39	HD 37	HD 35	HR 33 & 35	HD 33
	HD 53	HD 51	HR 49 & 51	HD 49	HD 47	HR 45 & 47	HD 45	HD 43
	HD 63	HR 61 & 63	HD 61	HD 59	HR 57 & 59	HD 57	HD 55	HR 53 & 55
	HR 73 & 75	HD 73	HD 71	HR 69 & 71	HD 69	HD 67	HR 65 & 67	HD 65
	HD 85	HD 83	HR 81 & 83	HD 81	HD 79	HR 77 & 79	HD 77	HD 75
72	HD 95	HR 93 & 95	HD 93	HD 91	HR 89 & 91	HD 89	HD 87	HR 85 & 87
80	HR 105 & 107	HD 105	HD 103	HR 101 & 103	HD 101	HD 99	HR 97 & 99	HD 97
88	HD 117	HD 115	HR 113 & 115	HD 113	HD 111	HR 109 & 111	HD 109	HD 107
96	HD 127	HR 125 & 127	HD 125	HD 123	HR 121 & 123	HD 121	HD 119	HR 117 & 119
104	Spare	Spare	Spare	Spare	Spare	HD 131	HR 129 & 131	HD 129
112	Shield Gnd	Shield Gnd	Spare	-20 Volts DC	Spare	Spare	Spare	Spare
120	-T Run Mode	+U Hi Spd Stop Ind	+U Lo Spd Stop Ind	+U Forms Check	+U Hi Spd Start Ind	+U Lo Spd Start Ind	Spare	Spare
128	Spare	Carr Inlk	Spare	Spare	DC Gnd	Spare	Spare	-12 Volts DC
136	-T Start Relay	Spare	-T End Of Forms	Chain Motor Relay	Print Conn Inlk 1	Spare	+U Print Ready Ind	Spare
144	+T Check Reset	+12 Volts DC	Sense Amp 2	Sense Amp 1	-6 Volts DC	+6 Volts DC	-T Restore Key	+U Restore Key
152	+U Single Cycle	-T Single Cycle	+U Print Check Ind	-T Stop Key	-6 Volts DC	+6 Volts DC	Spare	Spare
160	+U Sync Check Ind	+U Ends Of Forms Ind	-T Space Key	156 +U Space Key	+6 Volts DC	+U Not Start Key	153 +U Start Key	

Figure 13. IBM 1401 to IBM 1403 Signal Connector SC-1, (Wiring Side—Fixed Mount)

H D = Hammer Drive				H R = Hammer Return				
8	HR 10 & 12	HD 10	HD 8	HR 6 & 8	HD 6	HD 4	HR 2 & 4	HD 2
16		HD 20	HR 18 & 20	HD 18	HD 16	HR 14 & 16	HD 14	HD 12
24	HD 32	HR 30 & 32	HD 30	HD 28	HR 26 & 28	HD 26	HD 24	HR 22 & 24
32	HR 42 & 44	HD 42	HD 40	HR 38 & 40	HD 38	HD 36	HR 34 & 36	HD 34
40	HD 54	HD 52	HR 50 & 52	HD 50	HD 48	HR 46 & 48	HD 46	HD 44
48	HD 64	HR 62 & 64	HD 62	HD 60	HR 58 & 60	HD 58	HD 56	HR 54 & 56
56	HR 74 & 76	HD 74	HD 72	HR 70 & 72	HD 70	HD 68	HR 66 & 68	HD 66
64	HD 86	HD 84	HR 82 & 84	HD 82	HD 80	HR 78 & 80	HD 78	HD 76
72	HD 96	HR 94 & 96	HD 94	HD 92	HR 90 & 92	HD 90	HD 88	HR 86 & 88
80	HR 106 & 108	HD 106	HD 104	HR 102 & 104	HD 102	HD 100	HR 98 & 100	HD 98
88	HD 118	HD 116	HR 114 & 116	HD 114	HD 112	HR 110 & 112	HD 110	HD 108
96	HD 128	HR 126 & 128	HD 126	HD 124	HR 122 & 124	HD 122	HD 120	HR 118 & 120
104	Spare	Spare	Spare	Spare	Spare	HD 132	HR 130 & 132	HD 130
112	Shield Gnd	Shield Gnd	Spare	Spare	Spare	Spare	Spare	Spare
120	Spare	Spare	Spare	Spare	Spare	Spare	Spare	Spare
128		Spare	-60v Ctrl'd	Print Conn Inlk 2	Spare	Spare	Spare	Spare
136	Slow Brush 7	Slow Brush 6	Slow Brush 5	Slow Brush 4	Slow Brush 3	Slow Brush 2	Slow Brush 1	Slow Brush 1
144	Stop Brush 3	Stop Brush 2	Stop Brush 1	Slow Brush 12	Slow Brush 11	Slow Brush 10	Slow Brush 9	Slow Brush 8
152	Stop Brush 11	Stop Brush 10	Stop Brush 9	Stop Brush 8	Stop Brush 7	Stop Brush 6	Stop Brush 5	Stop Brush 4
160	+U Forms Check Ind	Emitter	High Speed Stop	High Speed Start	Low Speed Stop	Low Speed Start	Spare	153 Stop Brush 12

Figure 14. IBM 1401 to IBM 1403 Signal Connector, SC-2, (Wiring Side—Fixed Mount)

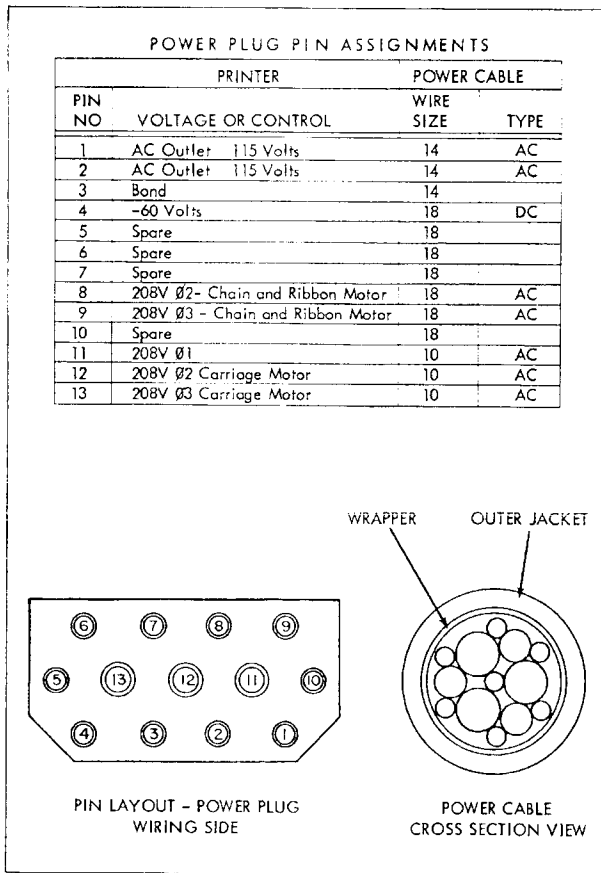

Figure 15. IBM 1401 to IBM 1403 Printer
Power Plug Pin Assignments

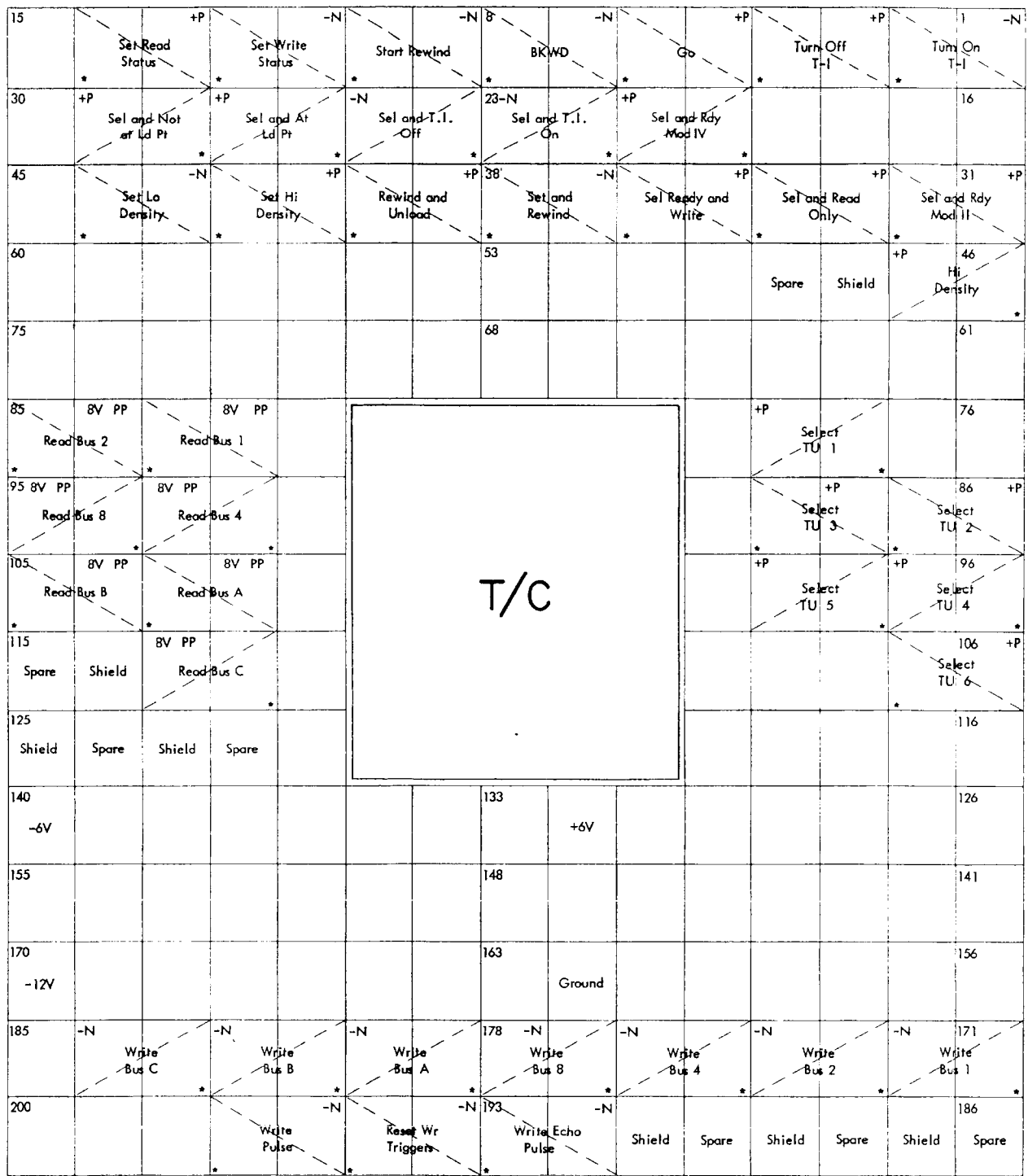

Figure 16. IBM 1401 to IBM 729 Magnetic Tape Unit Connector Receptacle (Wiring Side—Fixed Mount)

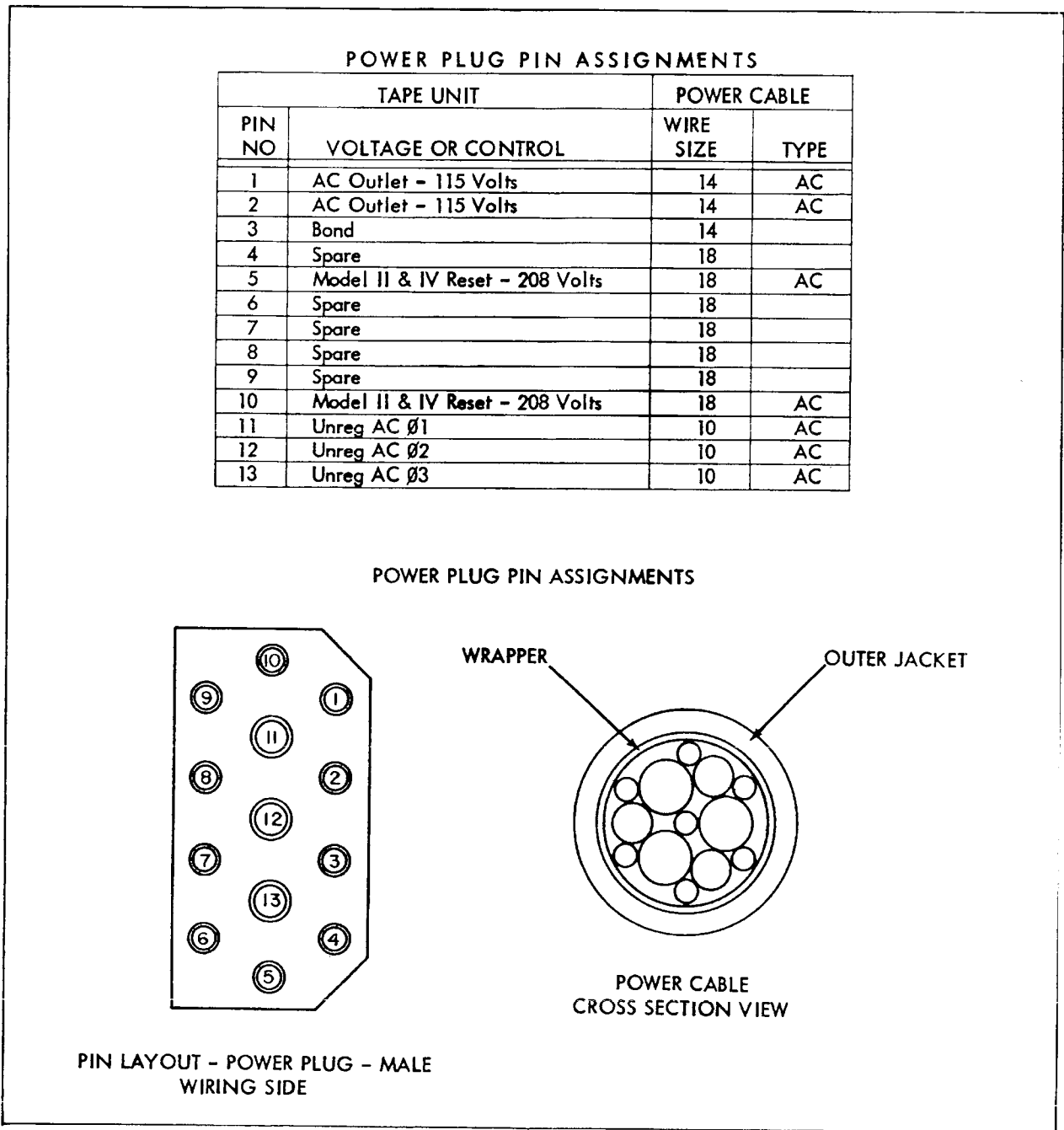

Figure 17. IBM 1401 to IBM 729 Magnetic Tape Unit Power Plug Pin Assignments

In Figure 18, the diagonal dotted line connecting pins 082 and 083 indicates that the two serve as a pair; that is, signal wire and reference wire for a given function. Signal level designator -C identifies connector 082 as the signal wire. An asterisk identifies connector 083 as the shield or reference wire.

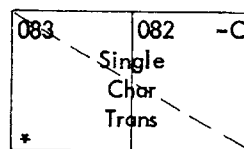

Figure 18.

Index

A-Address Register	6, 9	Logic Lights	10
Addressing System	6	Manual Address Switches	9
Address Stop Mode	9	Mode Switch	9
Alter Mode	9	Not I/O Read Call 1	16
A-Register	6	Not Start Reset Out	16
Auxiliary Console Keys, Switches and Lights	10	Operation Code	5
Backspace Key	10	Output Lines	14
B-Address Register	6, 9	Parity Check	7, 12
Bit Display Light	10	Physical Characteristics	7
Bit Switches	10, 12	Power Off Key	7
B-Register	6	Power On Key	7
Card Read-Punch Power Plug	23	Power Requirements	13
Character Display Mode	9	Printer Display Light	10
Checking	7	Printer Power Plug	25
Console Keys and Switches	7, 8, 9, 10	Processing Unit	5
Console Lights	10	Punch Connector	21
Core Storage	5	Punch Interlock Light	10
Customer Engineering Diagnostic Panel	11, 12	Read Continuous	12
Emergency Off Switch	8, 17	Read Interlock Light	10
End of Transmission	17	Read One Record	12
External Cable Layout	19	Reader Connector	22
Force Odd Red 1-Out	16	Reset A-Reg Error 1	16
Force Odd Red 2	17	Reset Transmission Error Latch	14
Function Select Switch	12	Run Mode	9
Functional Characteristics	5	Select 1 Out	16
Hole-Count Check	7	Select I/O Attachment	14
I-Address Register	6, 9	Select I/O In	17
Inhibit WM 1	16	Select I/O Out	17
Input Lines	17	Sense Switches	9
Input/Output Attachment	7	Service Request Out 1	17
Input/Output Signal Lines	14	Service Request Out 2	17
Instruction/Execution Mode	9	Service Response	15
Instruction Format	5, 6	Set Re-address Latch 1	16
Instruction Length Light	10	Set Write Latch Out	16
I/O Attachment Plug	20	Signal Connector SC-1	24
I/O Attachment Read Call	15	Signal Connector SC-2	24
I/O Attachment Write Call	15	Signal Levels	13
I/O Attention Light	18	Single Character Transmission	17
I/O Check Stop Switch	7	Single Cycle Non Process Mode	9
I/O Disconnect	15	Single Cycle Process Mode	9
I/O Disc Out 1	16	Start Key	7
I/O Disc Out 2	16	Start Reset Key	7
I/O Input Lines	18	Start Reset Out	16
I/O Load	18	Stop Key	8
I/O Output Lines	15	Storage Print Out Mode	9
I/O Process Check	14	Storage Scan Mode	9
I/O Re-address	17	Stored Programming	5
I/O Select Lines	15	Tape Load Key	10
I/O Selecting Unit	18	Tape Select Switch	9
I/O Service Request	17	Tape Unit Connector	26
I/O Trans 1	16	Tape Unit Power Plug	27
I/O Trans 2	16	Transmission Lines	13
I/O Transfer Lines	17	Validity Check	7, 12
I/O Write Call In	17	Word Mark	6, 7
I/O Write Call Out	17	Write Continuous	12
Line Driver	13, 14	Write Tape Mark	12
Line Terminator	13, 14	Write with Gaps	12



International Business Machines Corporation
Data Processing Division
112 East Post Road, White Plains, New York